

# Product Catalogue



**50** YEARS



# Hydraulic Specialties Pty Ltd - Product Catalogue

The Hyspecs product catalogue contains the most common hydraulic builds and parts that Hyspecs stocks. If the part you are after is not listed, please contact Hyspecs as we may have it in stock or may be able to re-configure existing stock. We carry over 10,000 different stock items.

- **Please refer to [my.hyspecs.com.au](http://my.hyspecs.com.au) for current pricing.**
- All performance and specification figures are taken from the latest possible literature and may vary from older literature versions.
- All pressure ratings shown in this catalogue are operating pressures. The operating pressure may be considerably higher than relief or pump compensator settings.
- It is the responsibility of the system designer to determine suitability of the component.
- A commissioning, assembly or product conversion fee may apply.
- Product photos shown are indicative only. Actual products may differ from that shown.
- Product contained in the catalogue are offered subject to Hyspecs' normal terms and conditions of sale.
- A restocking fee may apply on goods returned for credit.
- Where two manifold port sizes are listed the assembly price may cost more for the larger port size.
- Pressure or flow setting charges may apply.
- Solenoid valves come standard with flying leads (DC only) unless otherwise stated. AC coils are DIN plug only. Hirschman / DIN plugs are not included.
- Where needed banjo bolts are included.

## Suppliers of

• ASA • Ausco • Brand Hydraulics • Char-Lynn • Comer Planetary Drives • Bosch Rexroth • Bucher (Command Controls) • Danfoss • Eaton • Emmegi • EPE • Fairfield • Galtech • Gresen • Hydr-App • HydraForce • IFM • Kar-Tech • Koreson • KVT-Koenig • MICO • Northman • OMT • Poclairn • Tognella • Transducers Direct • Vickers • Walvoil • Webtec

## Contents

### Common Formulae and Conversions

i	Cylinders and Actuators Formulae – Metric Units
ii	Pumps and Motors Formulae – Metric Units
iii	Flow / Volume Conversion Table
iv	Power Conversion Table
v	Pressure Conversion Table
vi	Torque Conversion Table

### A - Pumps

A1	Gear Pumps
A5	Vane Pumps
A9	Hand Pumps
A11	Piston Pumps - Press./Press. Flow Compensated
A17	Piston Pumps - Closed Loop Medium Duty
A19	Piston Pumps - Closed Loop Heavy Duty

### B - Motors

B1	Geroler / Gerotor Motors
B12	Gear Motors
B14	Piston Motors - Fixed Displacement H.D.
B15	Piston Motors – Radial
B16	Piston Motors - Axial

### C - Hydrostatics

C1	Transmissions - Light Duty
----	----------------------------

### D - Control Valves

D1	Manual Valves
D6	Solenoid Valves & Accessories
D24	Proportional Cetop Valves
D26	Proportional Sectional Valves
D44	Diverter / Selector Valves
D47	Flow Control Valves
D50	Gauge Isolators
D50	Stainless Steel Valves
D51	Ball Valves
D51	Check Valves
D52	Reciprocating Valves

## Contents

### E - Hydraulic Power Packs

E1	AC / DC Modular Micro Power Pack
E3	AC / DC Power Pack
E4	Hyspecs Standard Power Packs

### F - Power Steering

F1	Power Steering Units
----	----------------------

### G - Filtration

G1	Filtration - Return
G3	Filtration - Medium Pressure
G4	Filtration - High Pressure
G5	Filtration - Suction
G5	Filtration Accessories

### H - Hydraulic Accessories

H1	Oil Coolers
H4	Accumulators
H6	Indicators / Gauges / Switches / Sensors / Fittings
H12	Hydraulic Test Equipment

### I - Drive Accessories

I1	Planetary Drives
I12	P.T.O. Gear Boxes
I13	Electromagnetic Clutches
I13	Over-Hung Load Adaptors
I14	Failsafe Brakes
I15	Spline Billets & Shafts
I16	Flexible Couplings, Bell Housings & Dampers



## Contents

### J - Oil Reservoirs

J1	Oil Reservoirs
J2	Smart Oil Reservoirs VVR

### K - Excavator Valving & Accessories

L1	Introduction
L2	Hydraulic Pilot Valves
L10	Quickhitch Valves
L12	Quickhitch Combination Valves
L16	Tilt Control Valves
L20	Tilt & Thumb Valves
L23	Flow Sharing Valves
L25	SAFEX™ Valves
L27	Relief Valves

### L - Electronic Controls

L1	Amplifier Plugs
L2	Joysticks
L3	Connectors
L4	Electronic Control Units
L6	Radio Remote Controls
L7	Proportional Controls & Joysticks
L7	Mobile and Off Highway Control Systems
L8	Industrial Control Systems
L8	HMI, Operator Controls and Sensors
L9	System Design, Programming, Commission & Support
L9	IOT (internet of things)
L9	Electrical Drives and ePTO's
L10	Synchronous Permanent Magnet Motors
L10	Motor Controllers
L10	Terzo EHPU
L11	Editron or eLion Drives

## Cylinders and Actuators Formulae - Metric Units

Symbol	Description	Units
Q	Flow Rate	l/min
A	Net Area	cm <sup>2</sup>
V	Piston Speed	m/sec
F	Force	N
P	Pressure	Bar

Symbol	Description	Units
D	Cylinder Bore Ø	cm
d	Rod Diameter	cm
V	Displacement	litres
L	Stroke Length	cm
t	Stroke Time	sec

**Net Area Piston Side:** 
$$A = \frac{\pi \times D^2}{4}$$

**Net Area Rod Side:** 
$$A = \frac{\pi}{4} \times (D^2 - d^2)$$

**Cylinder Force:** 
$$F = A \times p \times 10$$

**Cylinder Volume:** 
$$V_c = \frac{A \times L}{1000}$$

**Required Flow:** 
$$Q = A \times v \times 6$$

**Stroke Time:** 
$$t = \frac{0.06 \times A \times L}{Q}$$

## Pumps & Motors Formulae – Metric Units

Symbol	Description	Units
Q	Flow Rate	l/min
V	Displacement	cc
n	Shaft Speed	rpm
P	Power	kW
T	Torque	Nm

Symbol	Description	Units
P	Pressure	Bar
v	Vehicle Speed	Km/hr
r	Rolling radius	m
G	Gear Reduction	
η	Efficiency	

**Power - Pump:** 
$$P = \frac{Q \times p}{600}$$

**Power - Motor:** 
$$P = \frac{T \times n}{9,549}$$

**Flow:** 
$$Q = \frac{V \times n}{1,000}$$

**Torque:** 
$$T = \frac{p \times V}{20 \times \pi}$$

**Vehicle Drive:** 
$$n = \frac{2.65 \times v \times G}{r}$$

## Flow / Volume Conversion Table

### Exact Conversions

- 1 LPM = 0.264 GPM (U.S)
- 1 LPM = 0.221 GPM (Imp)
- 1 GPM (U.S.) = 3.785 LPM
- 1 GPM (Imp) = 4.524 LPM
- 1 m<sup>3</sup> = 1000 Litres
- 1 Litre = 1000 cm<sup>3</sup>
- 1 cm<sup>3</sup> = 0.061 in<sup>3</sup>
- 1 in<sup>3</sup> = 16.2 cm<sup>3</sup>

### Approximate Conversion Table

LPM	GPM (U.S)	GPM (Imperial)
1	0.3	0.2
5	1.3	1.1
10	2.6	2.2
15	4.0	3.3
20	5.3	4.4
25	6.6	5.5
30	7.9	6.6
35	9.2	7.7
40	10.6	8.8
45	11.9	9.9
50	13.2	11.1
55	14.5	12.2
60	15.9	13.3
65	17.2	14.4
70	18.5	15.5
75	19.8	16.6
80	21.1	17.7
85	22.5	18.8
90	23.8	19.9
95	25.1	21.0
100	26.4	22.1
110	29.1	24.3
120	31.7	26.5
130	34.3	28.7
140	37.0	30.9

# Power Conversion Table

## Exact Conversions

- 1 kW = 1.341 HP
- 1 HP = 0.7457 kW
- 1 cal/s = 4.1868 watts
- 1 kW = 56.92 Btu/min

## Approximate Conversion Table

kW	HP	cal/s	Btu/min
0.33	0.4	79	19
0.50	0.7	119	28
0.75	1.0	179	43
1	1.3	239	57
2	2.7	478	114
3	4.0	717	171
4	5.4	955	228
5	6.7	1194	285
8	10.7	1911	455
10	13.4	2388	569
15	20.1	3583	854
20	26.8	4777	1138
25	33.5	5971	1423
30	40.2	7165	1708
35	46.9	8359	1992
40	53.6	9554	2277
45	60.3	10748	2561
50	67.1	11942	2846
55	73.8	13136	3131
60	80.5	14330	3415
65	87.2	15525	3700
70	93.9	16719	3984
75	100.6	17913	4269
80	107.3	19107	4554
85	114.0	20301	4838



## Pressure Conversion Table

### Exact Conversions

- 1 Bar = 14.50 PSI
- 1 Bar = 100.00 kPa
- 1 Bar = 0.1 MPa
- 1 Bar = 1.02 kg/cm<sup>2</sup>
- 1 PSI = 0.0690 Bar
- 1 PSI = 6.895 kPa
- 1 PSI = 0.007 MPa
- 1 PSI = 0.07 kg/cm<sup>2</sup>

### Approximate Conversion Table

PSI	Bar	kPa	MPa
100	6.9	690	0.7
200	13.8	1379	1.4
300	20.7	2069	2.1
400	27.6	2759	2.8
500	34.5	3448	3.4
1000	69.0	6897	6.9
1250	86.2	8621	8.6
1500	103.4	10345	10.3
1750	120.7	12069	12.1
2000	137.9	13793	13.8
2250	155.2	15517	15.5
2500	172.4	17241	17.2
2750	189.7	18966	19.0
3000	206.9	20690	20.7
3250	224.1	22414	22.4
3500	241.4	24138	24.1
3750	258.6	25862	25.9
4000	275.9	27586	27.6
4250	293.1	29310	29.3
4500	310.3	31034	31.0
4750	327.6	32759	32.8
5000	344.8	34483	34.5
5500	379.3	37931	37.9
6000	413.8	41379	41.4
10000	689.7	68966	69.0

## Torque Conversion Table

### Exact Conversions

- 1 Nm = 0.7376 ft-lbs
- 1 Nm = 8.851 in-lbs
- 1 Nm = 0.102 kgm
- 1 ft-lbs = 1.356 Nm
- 1 in-lbs = 0.113 Nm
- 1 kgm = 9.807 Nm

### Approximate Conversion Table

Nm	ft-lbs	in-lbs	kgm
1	0.7	8.9	0.1
2	1.5	17.7	0.2
3	2.2	26.6	0.3
4	3.0	35.4	0.4
5	3.7	44.3	0.5
10	7.4	88.5	1.0
12	8.9	106.2	1.2
14	10.3	123.9	1.4
16	11.8	141.6	1.6
18	13.3	159.3	1.8
20	14.8	177.0	2.0
25	18.4	221.3	2.6
30	22.1	265.5	3.1
35	25.8	309.8	3.6
40	29.5	354.0	4.1
45	33.2	398.3	4.6
50	36.9	442.6	5.1
75	55.3	663.8	7.7
100	73.8	885.1	10.2
150	110.6	1327.7	15.3
200	147.5	1770.2	20.4
300	221.3	2655.3	30.6
400	295.0	3540.4	40.8
500	368.8	4425.5	51.0
600	442.6	5310.6	61.2

## Contents Section A - Pumps

### A1 Gear Pumps

A1	Group 1 Start Pumps	<i>Galtech</i>
A1	Pump Joiner Kits	<i>Galtech</i>
A2	Group 2 Start Pumps	<i>Galtech</i>
A3	Group 3 Start Pumps	<i>Galtech</i>
A4	2 Stage High/Low Pumps	<i>Deli</i>

### A5 Vane Pumps

A5	V10 & V20 Series	<i>Eaton/Vickers</i>
A6	VQ & VQT Series	<i>Eaton/Vickers</i>

### A9 Hand Pumps

A9	CS Series	<i>Galtech</i>
A9	CSI Series	<i>Galtech</i>
A10	HP Series – Cartridge	<i>HydraForce</i>

### A11 Piston Pumps – Press./Press. Flow Compensated

A11	220 Series	<i>Eaton</i>
A12	420 Series	<i>Eaton</i>
A13	620 Series	<i>Eaton</i>
A14	PVH Series	<i>Eaton</i>
A15	PVM Series	<i>Eaton</i>
A16	A10V Series	<i>Bosch Rexroth</i>

### A17 Piston Pumps – Closed Loop Medium Duty

A17	PM10 Series	<i>Poclain Hydraulics</i>
A18	A10VG	<i>Bosch Rexroth</i>

### A19 Piston Pumps – Closed Loop Heavy Duty

A19	HD Series	<i>Eaton</i>
-----	-----------	--------------

## Gear Pumps - Galtech



### Group 1 Gear Pumps

- Each individual pump is pre-set for rear connection to one or more pumps by the interposition of the appropriate coupling flange.
- Comes standard with Euro-mount 71.9 mm x 52.4 mm rectangular, spigot  $\varnothing 25.4$  mm, 1:8 taper shaft & flanged ports (BSPP threaded ports also available).

Model	Displacement cc/rev	Max. Cont. Pressure bar	Max. Speed rpm
1SP-A-090-D-EUR-B-N-10-0-N	0.89	260	6000
1SP-A-012-D-EUR-B-N-10-0-N	1.18	260	6000
1SP-A-016-D-EUR-B-N-10-0-N	1.6	260	6000
1SP-A-020-D-EUR-B-N-10-0-N	2.0	260	5500
1SP-A-025-D-EUR-B-N-10-0-N	2.5	260	5000
1SP-A-032-D-EUR-B-N-10-0-N	3.2	260	4500
1SP-A-037-D-EUR-B-N-10-0-N	3.7	250	4000
1SP-A-042-D-EUR-B-N-10-0-N	4.2	250	3500
1SP-A-050-D-EUR-B-N-10-0-N	5.0	250	3000
1SP-A-063-D-EUR-B-N-10-0-N	6.3	170	2700
1SP-A-078-D-EUR-B-N-10-0-N	7.76	170	2500

- Pumps can be supplied in either clockwise or anti-clockwise rotation.

Configuration Options	
Port type	Flanged ports (N), see below for flange accessories 3/8" BSPP (G) Threaded ports
Shaft type	1:8 Taper shaft (10) 1/2" Parallel keyed shaft (13)
Mounting flange type	Standard Euro-mount 71.9 mm x 52.4 mm rectangle SAE 'A-A' Two bolt mount
Relief valve	Integral relief valve built into the rear cover, internal exhaust (VLPI)

Accessories	
FG 3/8-26	Outlet flange, 90° elbow, 3/8" BSP, 26 PCD (0.9 – 2.0 pumps)
FG 3/8-30	Outlet flange, 90° elbow, 3/8" BSP, 30 PCD
FG 1/2-30	Inlet and outlet flange, 90° elbow, 1/2" BSP, 30 PCD
FI 30-3/8-Z-C	Inlet and outlet flange, straight port, 3/8" BSP, 30 PCD

### Pump Joiner Kits

Model	Description
01091100000000	Group 1 with Group 1 Start
01092110000000	Group 2 with Group 1 Start
01092200000000	Group 2 with Group 2 Start
010G3100000000	Group 3 with Group 1 Start
010G3200000000	Group 3 with Group 2 Start
010G3300000000	Group 3 with Group 3 Start
01091101000000	Group 1 with Group 1 Short tandem (TC)
01092201000000	Group 2 with Group 2 Short tandem (TC)
010G3101000000	Group 3 with Group 1 Short tandem (TC)
010G3210000000	Group 3 with Group 2 Short tandem (TC)
010G3310000000	Group 3 with Group 3 Short tandem (TC)





## Gear Pumps - Galtech

### Group 2 Gear Pumps

- 12 tooth gears and consequent decrease in noise levels.
- High working pressures.
- Flange and cover in aluminium or on request, cast iron (for higher pressure).
- Each individual pump is pre-set for rear connection to one or more pumps by interposition of the appropriate coupling flange.
- Comes standard with Euro-mount 96.2 mm x 71.5 mm rectangular, spigot  $\varnothing 36.5$  mm, 1:8 taper shaft & flanged ports (BSPP threaded ports also available).

Model	Displacement cc/rev	Max. Cont. Pressure bar	Max. Speed rpm
2SP-A-040-D-EUR-B-N-10-0-N	4.0	250	4000
2SP-A-060-D-EUR-B-N-10-0-N	6.0	250	4000
2SP-A-080-D-EUR-B-N-10-0-N	8.5	250	3500
2SP-A-110-D-EUR-B-N-10-0-N	11.0	250	3500
2SP-A-140-D-EUR-B-N-10-0-N	14.0	250	3500
2SP-A-160-D-EUR-B-N-10-0-N	16.5	230	3500
2SP-A-190-D-EUR-B-N-10-0-N	19.5	210	3300
2SP-A-220-D-EUR-B-N-10-0-N	22.5	190	2800
2SP-A-260-D-EUR-B-N-10-0-N	26.0	170	2500

- Pumps can be supplied in either clockwise or anti-clockwise rotation.
- Pumps are available with cast iron end plates for higher working pressures – *Consult Hyspecs*

Configuration Options	
Port type	Flanged ports (N), see below for flange accessories BSPP Threaded (G) 1/2" Pressure & 1/2" Suction to 8.5 cc and 3/4" above UNO Threaded Ports (U)
Shaft type	1:8 Taper shaft (10) 5/8" Parallel keyed shaft (13) 5/8" 9 Tooth spline (14) 10 Tooth spine - (40) - available in 8.5, 11.0 and 26.0 cc pumps only
Mounting flange type	Standard Euro-mount 96.2 mm x 71.5 mm rectangle SAE 'A' Two bolt mount
Relief valve	Integral relief valve built into the rear cover, internal exhaust (VLPI)

Accessories	
FG 3/8-30	Outlet flange, 90° elbow, 3/8" BSP, 30 PCD
FG 1/2-30	Inlet & Outlet flange, 90° elbow, 1/2" BSP, 30 PCD
FG 1/2-40	Inlet & Outlet flange, 90° elbow, 1/2" BSP, 40 PCD
FG 3/4-40	Inlet flange, 90° elbow, 3/4" BSP, 40 PCD
FI 30-3/8-Z-C	Outlet flange, straight port, 3/8" BSP, 30 PCD
FI 40-1/2-Z-C	Outlet flange, straight port, 1/2" BSP, 40 PCD
015291050010100	Front Euro-mount kit with bearing for shaft side loading



## Gear Pumps - Galtech



### Group 3 Gear Pumps

- 12 tooth gears & consequent decrease in noise levels.
- High working pressures.
- Flange and cover in cast iron.
- Each individual pump is pre-set for rear connection to one or more pumps by interposition of the appropriate coupling flange.
- Comes standard with Euro-mount 128 mm x 98 mm rectangular, spigot  $\varnothing 50.8$  mm, 1:8 taper shaft & flanged ports (BSPP threaded ports also available).

Model	Displacement cc/rev	Max. Cont. Pressure bar	Max. Speed rpm
3GP-G-190-D-EUR-B-N-10-0-N	19.3	250	3500
3GP-G-230-D-EUR-B-N-10-0-N	23.0	250	3500
3GP-G-300-D-EUR-B-N-10-0-N	30.2	240	3300
3GP-G-340-D-EUR-B-N-10-0-N	33.8	240	3300
3GP-G-370-D-EUR-B-N-10-0-N	37.5	230	3300
3GP-G-440-D-EUR-B-N-10-0-N	44.6	220	3000
3GP-G-530-D-EUR-B-N-10-0-N	53.0	210	3000
3GP-G-620-D-EUR-B-N-10-0-N	62.7	190	2500

- Pumps can be supplied in either clockwise or anti-clockwise rotation.
- Larger displacements available on request – *Consult Hyspecs*

Configuration Options	
Port type	Flanged ports (N), see below for flange accessories BSPP Threaded Ports (G) 3/4" Pressure & 1" Suction
Shaft type	1:8 Taper shaft (10) 7/8" Parallel keyed shaft (13) 7/8" 13 Tooth spline (14)
Mounting flange type	Standard Euro-mount 128 mm x 98 mm rectangle SAE 'B' Two bolt mount
Relief valve	Integral relief valve built into the rear cover, internal exhaust - VLPI

Accessories	
FG 1/2-40	Inlet & Outlet flange, 90° elbow, 1/2" BSP, 40 PCD
FG 3/4-40	Outlet flange, 90° elbow, 3/4" BSP, 40 PCD
FG 1-51	Inlet flange, 90° elbow, 1" BSP, 51 PCD
FI 40-1/2-Z-C	Outlet flange, straight port, 1/2" BSP, 40 PCD

## Gear Pumps – 2 Stage

- 2 volume High/Low hydraulic pumps are compact, two stage, external gear pumps designed for use at elevated pressures. They are ideal for press-type applications (such as a log splitter, press, machine tools) requiring fast approach/retract speeds and slower peak actuator work speeds because of horsepower limitations or safety constraints.



### Bucher (Deli) 2 Stage High/Low Gear Pumps

Model	Displacement		Max. Pressure	Max. Speed
	High Pressure Gear Displ. <i>cc/rev</i>	Low Pressure Gear Displ. <i>cc/rev</i>		
CBN-6.3/3.0	3.0	6.3	210 <i>bar</i>	3600 <i>rpm</i>
CBN-8.8/3.0	3.0	8.8	210	3600
CBN-13.0/4.2	4.2	13.0	210	3600

- Unloaded adjustment 28-63 bar on all pumps (45 bar preset).
- NB: **Add** sizes together for maximum low-pressure flow.
- Pressures and speeds shown are maximums.

## Vane Pumps – Eaton/Vickers



### V10 & V20 Series

- Fixed displacement balanced vane pump. Single or double pumps.

### Single Pumps

Model	Displacement <i>cc/rev</i>	Max. Pressure <i>bar</i>	Max. Speed <i>rpm</i>
V10	3.3	172	4800
V10	6.6	172	4500
V10	9.8	172	4000
V10	13.1	172	3400
V10	16.4	172	3200
V10	19.5	152	3000
V10	22.8	138	2800
V20	16.4	172	3400
V20	19.5	172	3000
V20	22.8	172	2800
V20	26.5	172	2800
V20	29.7	172	2800
V20	36.4	172	2500
V20	39.0	152	2400
V20	42.5	152	2400

- V10 has 1 5/16" UNO suction and 3/4" UNO pressure ports, SAE A mount
- V20 has 1 5/8" UNO suction and 1 1/16" UNO pressure ports, SAE A mount

### Double Pumps

Model	Displacement Shaft End <i>cc/rev</i>	Displacement Rear Cover End <i>cc/rev</i>	Max. Pressure <i>bar</i>	Max. Speed <i>rpm</i>
V2010	19.5	3.3	172	3000
V2010	22.8	6.6	172	3000
V2010	26.5	9.8	172	2800
V2010	29.6	13.1	172	2800
V2010	36.4	16.4	172	2500
V2010	39.0	19.5	152	2400
V2010	42.5	22.8	152	2400
V2020	19.5	19.5	172	3000
V2020	22.8	22.8	172	3000
V2020	26.5	26.5	172	2800
V2020	29.6	29.6	172	2800
V2020	36.4	36.4	172	2500
V2020	39.0	36.4	152	2400
V2020	42.5	36.4	152	2400

- V10 has 1 5/16" UNO suction and 3/4" UNO pressure ports, SAE A mount.
- V20 has 1 5/8" UNO suction and 1 1/16" UNO pressure ports, SAE A mount.



## Vane Pumps – Eaton/Vickers

### V10 & V20 Series (continued)

Configuration Options – Single Pumps
3/4" Straight keyed shaft
5/8" 9T shaft
3/4" 11T shaft (V20 only)
Flow control head – V10
Priority head – V10
Flow control head – V20
Priority head – V20

- For flow rate and relief valve settings please *contact Hyspecs*.

### VQ & VQ(T) Series

- Fixed displacement high speed, pressure balanced vane pump.
- Single or double pumps, through drive option



### Single Pumps - VQ

Model	Displacement Cc/Rev	Max. Pressure bar	Max. Speed rpm	Pressure Port Code 61	Suction Port Code 61	Mount
20VQ	6.6	210	2700	3/4"	1 1/2"	SAE B
20VQ	18	210	2700	3/4"	1 1/2"	SAE B
20VQ	19	210	2700	3/4"	1 1/2"	SAE B
20VQ	27	210	2700	3/4"	1 1/2"	SAE B
20VQ	29	210	2700	3/4"	1 1/2"	SAE B
20VQ	35	210	2700	3/4"	1 1/2"	SAE B
20VQ	40	158	2700	3/4"	1 1/2"	SAE B
20VQ	45	138	2700	3/4"	1 1/2"	SAE B
25VQ	40	210	2700	1"	1 1/2"	SAE B
25VQ	45	210	2700	1"	1 1/2"	SAE B
25VQ	55	210	2500	1"	1 1/2"	SAE B
25VQ	62	210	2500	1"	1 1/2"	SAE B
25VQ	68	210	2500	1"	1 1/2"	SAE B

## Vane Pumps – Eaton/Vickers



### Single Pumps – VQ (continued)

Model	Displacement cc/rev	Max. Pressure bar	Max. Speed rpm	Pressure Port Code 61	Suction Port Code 61
35VQ	68	210	2500	1 1/4"	2"
35VQ	82	210	2500	1 1/4"	2"
35VQ	98	210	2500	1 1/4"	2"
35VQ	113	210	2400	1 1/4"	2"
35VQ	122	210	2400	1 1/4"	2"
					Code 62
45VQ	139	172	2200	1 1/2"	3"
45VQ	155	172	2200	1 1/2"	3"
45VQ	162	172	2200	1 1/2"	3"
45VQ	188	172	2200	1 1/2"	3"
45VQ	193	172	2200	1 1/2"	3"

#### Configuration Options

7/8" straight keyed or 7/8" 13T shaft - 20VQ, 25VQ, 30VQ

1 1/4" straight keyed or 1 1/4" 14T shaft - 35VQ, 45VQ

### Single Pumps – VQT

- Single vane pump with through drive option.

Model	Rear Mount	Displacement cc/rev	Max. Speed rpm	Shaft	Max Input Torque* Nm	Max Rear Torque Nm
25VQT	SAE A	All sizes as per 25VQ	As per 25VQ	1" straight	400	131
	SAE B			7/8" 13T	316	316
35VQT	SAE A	All sizes as per 35VQ	As per 35VQ	1 3/8" straight	659	131
	SAE B			1 1/4" 14T	791	437
	SAE C				791	437
45VQT	SAE A	All sizes as per 45VQ	As per 45VQ	1 1/2" straight	810	131
	SAE B			1 1/4" 14T	1017	702
	SAE C				1017	702

\* Input torque is a combination of front and back units on VQT.



## Vane Pumps – Eaton/Vickers



### Double Pumps – VQ

- Double vane pump, single inlet

Model	Displacement cc/rev		Max Pressure bar	Max. Speed rpm	Pressure Port	Suction Port Code 61	Mount
	Front	Rear					
2520VQ	40	18	As per 20VQ & 25VQ except rear cartridge 40cc = 158 45cc = 138	All 2700 except 55cc & 68cc max 2500	As per 20VQ & 25VQ	2 1/2"	SAE B
2520VQ	45	27				2 1/2"	SAE B
2520VQ	55	35				2 1/2"	SAE B
2520VQ	61	40				2 1/2"	SAE B
2520VQ	68	45				2 1/2"	SAE B
3520VQ	82	18	As per 20VQ & 35VQ except rear cartridge 40cc = 158 45cc = 138	All 2500 except 113cc & 122cc max 2400	As per 20VQ & 35VQ	3"	SAE C
3520VQ	98	27				3"	SAE C
3520VQ	113	35				3"	SAE C
3520VQ	122	40				3"	SAE C
3520VQ	-	45				3"	SAE C
4520VQ	139	18	As per 20VQ & 45VQ except rear cartridge 40cc = 158 45cc = 138	All 2200	As per 20VQ & 45VQ	3 1/2"	SAE C
4520VQ	155	27				3 1/2"	SAE C
4520VQ	162	35				3 1/2"	SAE C
4520VQ	188	40				3 1/2"	SAE C
4520VQ	193	45				3 1/2"	SAE C
3525VQ	68	-	As per 35VQ & 25VQ	All 2700 except 113cc & 122cc max 2400	As per 35VQ & 25VQ	3"	SAE C
3525VQ	82	40				3"	SAE C
3525VQ	98	45				3"	SAE C
3525VQ	113	55				3"	SAE C
3525VQ	122	68				3"	SAE C
4525VQ	139	40	As per 45VQ & 25VQ	All 2200	As per 45VQ & 25VQ	3 1/2"	SAE C
4525VQ	155	45				3 1/2"	SAE C
4525VQ	162	55				3 1/2"	SAE C
4525VQ	188	68				3 1/2"	SAE C
4525VQ	193	-				3 1/2"	SAE C
4535VQ	139	82	As per 45VQ & 35VQ	All 2200	As per 45VQ & 35VQ	4"	SAE C
4535VQ	155	98				4"	SAE C
4535VQ	162	113				4"	SAE C
4535VQ	188	122				4"	SAE C
4535VQ	193	-				4"	SAE C

#### Configuration Options

7/8" straight keyed or 7/8" 13T shaft – 2520VQ

1 1/4" straight keyed or 1 1/4" 14T shaft – 3520VQ, 4520VQ, 3525VQ, 4525VQ, 4535VQ

## Hand Pumps - Galtech



### CS Series – Double Acting With Relief

Model	Displacement <i>cc/rev</i>	Max. Pressure <i>bar</i>	Reservoir <i>litre</i>
CSN25VS-4-1-1	25	350	1
CSN25VS-4-2-1	25	350	2
CSN25VS-4-3-1	25	350	3
CSN25VS-4-5-1	25	350	5
CSN45VS-4-1-1	45	280	1
CSN45VS-4-2-1	45	280	2
CSN45VS-4-3-1	45	280	3
CSN45VS-4-5-1	45	280	5

### CSI Series – Double Acting, Flow Reverser And Relief

Model	Displacement <i>cc/rev</i>	Max. Pressure <i>bar</i>	Reservoir <i>litre</i>
CSIN12VS-4-1-1	12	380	1
CSIN12VS-4-2-1	12	380	2
CSIN12VS-4-3-1	12	380	3
CSIN12VS-4-5-1	12	380	5
CSIN25VS-4-1-1	25	350	1
CSIN25VS-4-2-1	25	350	2
CSIN25VS-4-3-1	25	350	3
CSIN25VS-4-5-1	25	350	5
CSIN25VS-4-10-1	25	350	10
CSIN45VS-4-1-1	45	280	1
CSIN45VS-4-2-1	45	280	2
CSIN45VS-4-3-1	45	280	3
CSIN45VS-4-5-1	45	280	5
CSIN45VS-4-10-1	45	280	10

## Hand Pumps - Hydraforce



### HP Series – Single Action, No Reservoir

Model	Description	Displacement <i>cc/rev</i>	Max. Pressure <i>bar</i>
HP10-20D/T-0-N	Cartridge	1.36	207
HP10-21A-0-N-A	Cartridge	7.4	207
6502340	Handle	-	-
HS1020P8	1/2" BSPP Manifold	-	207

Model	Description	Displacement <i>cc/rev</i>	Max. Pressure <i>bar</i>
HP16-21A-0-N	Cartridge	21.32	207
6502340	Handle	-	-
HS1620P12	3/4" BSPP Manifold	-	207

#### HP Hydraforce Hand Pump

##### Description

- A screw-in, cartridge-style, push or pull type hand pump with two built-in checks

##### Features

- Hardened parts for long life.
- Handle Beam rotates 360°
- Push or pull linkage standard.
- Heavy-duty construction.
- Industry common cavity.
- Displacement up to 10.6 cc (0.65 cu in.) per stroke

## Piston Pumps - Press./ Press. Flow Compensated - Eaton



### 220 Series B

- The Eaton® 220 open-circuit piston pump is built to maximize machine performance and productivity. With sophisticated controls that enhance system efficiency and a compact design that delivers incredible power, the 220 empowers mobile machine operators to do more work in less time using less fuel.

Max Displacement	cc/rev	28.0
Max. Speed	rpm	3000
Flow*	lpm	80
Cont. Pressure	bar	280
Max. Int. Pressure	bar	320
Max. Input Power Theoretical	kW	39.2
Cont. Inlet Temp	°C	93
Mounting Flange		2 Bolt SAE B

\* @ max. continuous pressure and rpm

Model	Description
222AK00028B	28cc/rev, SAEB 2-bolt mount, Ø 7/8" 13T splined shaft, side ports

**NOTE:** Shaft, mount, displacement and control options are available on request – *Consult Hyspecs*

### 220 Series B

#### Features

- Pressure compensated or load sense
- Small, space-saving size fits into more system applications
- Minimal number of separate parts reduces service needs

#### Applications

- Tele handlers, Backhoe Loaders, Skid Steer and more

## Piston Pumps - Press./ Press. Flow Compensated - Eaton



### 420 Series C (Danfoss X20)

- Maximize power density with the small but powerful 420 series pumps from Eaton. Ideal solutions for applications with constrained space, 420 Series pumps are available with displacements ranging from 41 cc to 80 cc.

Max Displacement	cc/rev	41.0**	49.2	62.3	80.0
Max. Speed	rpm	2650	2650	2600	2500
Flow	lpm	104	126	156	166
Cont. Pressure	bar	280	280	280	210
Max. Int. Pressure	bar	320	320	320	230
Max. Power Theoretical	kW	50.7	60.8	75.6	61.7
Cont. Inlet Temp	°C	93	93	93	93
Mounting Flange		2 bolt SAE B	2 bolt SAE B	2 bolt SAE B	2 bolt SAE B or C

\* Theoretical

\*\* Available on indent order only

Model	Description
ADU041	41cc/rev, SAEB 2-bolt mount, Ø 7/8" 13T splined shaft, rear ports
ADU049	49cc/rev, SAEB 2-bolt mount, Ø 7/8" 13T splined shaft, rear ports
ADU062	62cc/rev, SAEB 2-bolt mount, Ø 1" 15T splined shaft, rear ports
ADU080	80cc/rev, SAEB 2-bolt mount, Ø 1" 15T splined shaft, side ports

Configuration Options	
9900194-003	Seal kit
9900194-004	Adjustable maximum displacement stop kit

**NOTE:** Shaft, mount, displacement and control options are available on request – Consult Hyspecs

### 420 Series C

#### Features

- Pressure compensated or load sense
- Small, space-saving size fits into more system applications
- Minimal number of separate parts reduces service needs

#### Applications

- Tele handlers, Backhoe Loaders, Skid Steer and more



## Piston Pumps - Press./ Press. Flow Compensated - Eaton



### 620 Series B

- The Eaton® 620 open-circuit piston pump is built to maximize machine performance and productivity. With sophisticated controls that enhance system efficiency and a compact design that delivers incredible power, the 620 empowers mobile machine operators to do more work in less time using less fuel.

Max Displacement	cc/rev	74.4	98.0
Max. Speed	rpm	2400	2200
Flow*	lpm	168	200
Cont. Pressure	bar	310	280
Max. Int. Pressure	bar	346	320
Max. Power Theoretical	kW	92.3	100.6
Cont. Inlet Temp	°C	93	93
Mounting Flange		4 Bolt SAE C	4 Bolt SAE C

\* @ max continuous pressure and rpm

Model	Description
622AK00131B	74.4 cc/rev, SAEC 4-bolt mount, Ø 1¼" 14T splined shaft, side ports
622AK00472B	98.0 cc/rev, SAEC 4-bolt mount, Ø 1½" 17T splined shaft, side ports

**NOTE:** Shaft, mount, displacement and control options are available on request – *Consult Hyspecs*

### 620 Series B

#### Features

- Pressure compensated or load sense
- Small, space-saving size fits into more system applications
- Minimal number of separate parts reduces service needs

#### Applications

- Tele handlers, Backhoe Loaders, Skid Steer and more



## Piston Pumps - Press./ Press. Flow Compensated - Eaton

### PVH Series - Mobile

- Get the power of Eaton technology—including their precision manufacturing and proven inline piston design—in a small, light and quiet package: the PVH Series. Optimized for up to 250 bar, high flow, continuous duty applications on mobile equipment, PVH Series pumps are perfect for equipment like skid steer loaders, boom lifts and more.

Max Displacement	cc/rev	57	74	98	131
Max. Speed	rpm	3000	2750	2600	2500
Max. Flow**	lpm	134	156	202	249
Press. Δbar	bar	250	250	250	250
Cont. Inlet Temp	°C	82	82	82	82
Mounting Flange		4 Bolt SAE C	4 Bolt SAE C	4 Bolt SAE C	4 Bolt SAE C

\*\* @ max continuous flow and max. continuous pressure

57cc – 131cc are priced as standard with through shaft and SAE A rear mount.

Model	Description
PVH – 57 cc	57 cc/rev, SAE C four bolt mount, through drive with SAE A pad Ø 1 1/4" 14T splined shaft, side ports, press./ flow compensated
PVH – 74 cc	74 cc/rev, SAE C four bolt mount, through drive with SAE A pad Ø 1 1/4" 14T splined shaft, side ports, press./ flow compensated
PVH – 98 cc	98 cc/rev, SAE C four bolt mount, through drive with SAE A pad Ø 1 1/2" 17T splined shaft, side ports, press./ flow compensated
PVH – 131 cc	131 cc/rev, SAE C four bolt mount, through drive with SAE A pad Ø 1 1/2" 17T splined shaft, side ports, press./ flow compensated

**NOTE:** Shaft, mount, displacement and control options are available on request – *Consult Hyspecs*

#### PVH Series

##### Features

- Full range of controls and multiple shaft and mounting options increase flexibility of possible applications
- Durable construction promotes maximum operational reliability
- Small, lightweight design reduces noise for sensitive applications

##### Applications

- Skid Steer Loader, Boom lifts, Machine Tool, Plastics, Construction and more

## Piston Pumps - Press./ Press. Flow Compensated - Eaton

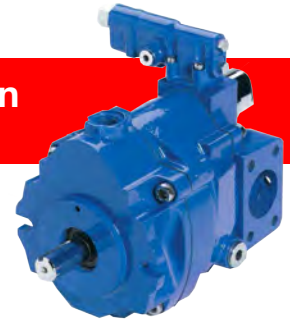

### PVM Series – Industrial Pumps

- Press brakes, injection moulding machines, extruders—many kinds of applications that require a wide displacement range all benefit from Eaton PVM Series piston pumps. With a variable displacement from 18 cc to 141 cc (1.1 to 8.6 cu in) at operating pressures up to 315 bar and a host of advanced features, the PVM Series piston pump reduces noise levels by more than 50% for quiet, effective operation.

Max Displacement	cc/rev	18.0*	45.1*	57.4*	73.7*	98.3*	131.0*
Max. Speed	rpm	1800	1800	1800	1800	1800	1800
Max. Flow**	lpm	31	76	102	127	170	215
Press. Δbar	bar	280	280	280	280	280	280
Max Case Press	bar	0.5	0.5	0.5	0.5	0.5	0.5
Input Power**	kW	16	41	52	63	88	113
Cont. Inlet Temp	°C	82	82	82	82	82	82
Mounting Flange		2 Bolt SAE A	2 Bolt SAE B	4 Bolt SAE C	4 Bolt SAE C	4 Bolt SAE C	4 Bolt SAE C

\* **NOTE:** 10% higher displacements are available at reduced operating pressures - *Consult Hyspecs*

\*\* @ 210 bar and 1800 rpm

57cc – 131cc are priced as standard with through shaft and SAE A rear mount.  
Standard build includes industrial ER plate with right hand rotation.

Model	Description
PVM – 18 cc	18 cc/rev, SAE A two bolt mount, Ø 5/8" parallel shaft, side ports, press./ flow compensated
PVM – 45 cc	45 cc/rev, SAE B two bolt mount, Ø 7/8" parallel shaft, side ports, press./ flow compensated
PVM – 57 cc	57 cc/rev, SAE C four bolt mount, through drive with SAE A pad Ø 1 1/4" parallel shaft, side ports, press./ flow compensated
PVM – 74 cc	74 cc/rev, SAE CC four bolt mount, through drive with SAE A pad Ø 1 1/2" parallel shaft, side ports, press./ flow compensated
PVM – 98 cc	98 cc/rev, SAE CC four bolt mount, through drive with SAE A pad Ø 1 1/2" parallel shaft, side ports, press./ flow compensated
PVM – 131 cc	131 cc/rev, SAE CC four bolt mount, through drive with SAE A pad Ø 1 1/2" parallel shaft, side ports, press./ flow compensated

#### Configuration Options

Through shaft kits - (18 to 45 cc)

**NOTE:** Shaft, mount, displacement and control options are available on request – *Consult Hyspecs*

**Piston Pumps - Press./ Press. Flow Compensated – Bosch Rexroth**

**A10V Series – Industrial Piston Pump**

- All-purpose medium pressure pump, open circuit
- Size 18 (A10VSO), Sizes 28 to 140 (A10VO)
- Nominal pressure 280 bar, Maximum pressure 350 bar



**Features**

- Variable pump with axial piston rotary group in swashplate design for hydrostatic drives in open circuit.
- Flow is proportional to drive speed and displacement. The flow can be smoothly changed by adjusting the swashplate.
- 2 drain ports
- Excellent suction characteristics
- Low noise level, Long service life
- Good power to weight ratio
- Versatile controller range
- Short control time
- The through drive is suitable for adding gear pumps and axial piston pumps up to the same size, i.e., 100% through drive.

**Technical data, standard unit**

Max Displacement*	cc/rev	18	28	45	71
Max. Speed	rpm	3300	3000	2600	2200
Max. Flow**	lpm	59	84	117	156
Press. Δbar	bar	280	280	280	280
Cont. Inlet Temp	°C	82	82	82	82
Mounting Flange		2 Bolt SAE A	2 Bolt SAE B	2 Bolt SAE B	2 Bolt SAE C

\* Larger displacements and higher speeds available on request (88, 100 and 140 cc/rev).

## Piston Pumps - Closed Loop Medium Duty Poclain Hydraulics



### PM Series

- Poclain PM series is a variable displacement, axial piston pump, with swashplate system, for closed loop hydrostatic transmissions. It provides a continuously variable flow rate between zero and maximum in forward and reverse direction. Flow rate is proportional to rotation speed and swashplate angle.

Model		PM10-09	PM10-14	PM10-21	PM50-40
Max. Displacement	cc/rev	9.08	14.32	20.40	40.00
Max. Flow	lpm	32.7	51.6	73	144
Rated Speed	rpm	3600	3600	3600	3400
Rated Pressure	bar	210	210	210	300
Max. Pressure	bar	350	350	350	400
Max. Absorbed Power	kW	19.1	30.1	42.6	76.8

Model	Description
PM10-09	Single pump, 9.08 cc, SAE A or SAE B mount, splined shaft Control options below Charge pump SAE A auxiliary mounting pad
PM10-14	Single pump, 14.32 cc, SAE A or SAE B mount, splined shaft Control options below Charge pump SAE A auxiliary mounting pad
PM10-21	Single pump, 20.40 cc, SAE A or SAE B mount, splined shaft Control options below Charge pump SAE A auxiliary mounting pad
PM50-40	Single pump, 40.00 cc, SAE BB mount, 7/8" 13T splined shaft Control options below Charge pump SAE A auxiliary mounting pad

#### Configuration Options - Numerous other configuration options are available on request:

Mechanical servo control
Hydraulic servo control
Hydraulic automotive control
Electrical on-off control
Electro-proportional control
Pumps can also be configured to double pump with auxiliary mount

#### PM Series - Features

- Variable displacement
- For closed loop circuits
- Rugged and compact
- Integral charge pump
- Tandem mounting available
- Mounting flange: SAE A, SAE B, SAE BB

## Piston Pumps - Closed Loop Medium Duty Bosch Rexroth

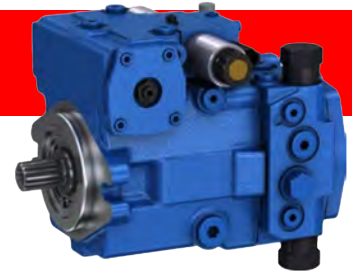

### A10VG Series

Hydrostatic closed circuit transmissions benefit from the A10VG's infinitely variable drive speed and displacement proportions.

- Medium pressure pump, for closed circuit applications
- Size 18 to 63 cc/rev
- Nominal pressure 300 bar, Maximum pressure 350 bar

### Features

- Variable axial piston pump of swash plate design for hydrostatic closed circuit transmission
- Flow is proportional to drive speed and displacement and is infinitely variable
- Output flow increases with the swivel angle of the swash plate from 0 to its maximum value
- Flow direction changes smoothly when the swash plate is moved through the neutral position
- A wide range of highly adaptable control devices is available for different control and regulating functions
- The pump is equipped with two pressure-relief valves on the high-pressure ports to protect the hydrostatic transmission (pump and motor) from overload
- The high-pressure relief valves also function as boost valves – The integrated boost pump acts as a feed and control oil pump
- The maximum boost pressure is limited by a built-in boost pressure relief valve

### Technical data

Max Displacement*	cc/rev	18	28	45	63
Max. Speed at Max. Displ.	rpm	4000	3900	3300	3000
Max. Flow**	lpm	72	109	152	189
Press. Δbar	bar	300	300	300	300
Cont. Inlet Temp	°C	82	82	82	82
Mounting Flange		2 Bolt	2 Bolt	2 Bolt	2 Bolt
		SAE A	SAE B	SAE B	SAE C

## Piston Pumps - Closed Loop Heavy Duty - Eaton

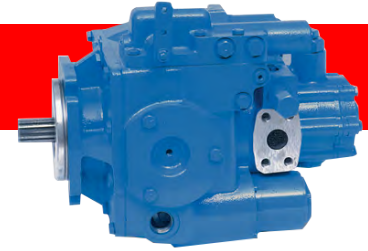

### HD Series

Model		39	46	54	64	76
Displacement	cc/rev	63.7	75.3	89.1	105.5	124.8
Max. Speed @ 18° Cam Angle***	rpm	4160	4160	3720	3720	2775
Max. Flow	lpm	255	300	318	375	333
Input Torque*	Nm	265	315	371	441	514
Press. Δbar	bar	241	241	241	241	241

\* Input torque @ 241 bar

\*\* At 15° swash angle

\*\*\* Max. pump speed may be limited by the charge pump speed rating.

- Pump performance calculated @ 96% efficiency.

Model	Displacement cc/rev
3923-XXX	63.7
4623-XXX	75.3
5423-XXX	89.1
6423-XXX	105.5
7620-XXX	124.8

Above Pricing Includes;

- Manual controller, 13.8 cc charge pump
- Code 61, 1" SAE main ports
- XXX - Identifies specific unit configuration - *Consult Hyspecs*
- **N.B. Auxiliary cooling is recommended**

#### Configuration Options

Spline, taper, and parallel keyed shaft versions available

21 cc charge pump - (except 64-76)

28 cc charge pump - (33-54)

35 cc charge pump - (64-76)

SAE A pad auxiliary mount.

SAE B pad auxiliary mount.

SAE C pad auxiliary mount.

Neutral detent

Neutral lockout

Electro-proportional control

Hydraulic remote

Inching valve

Internal pressure over-ride

Pressure over-ride

Remote pressure over-ride

Anti-stall with de-stroke valve

External servo stop adjustment

Stroke Limiter

Tachometric auto displacement control

#### HD Series

##### Features

- Self-lubricating, sealed systems are more responsive and easier to operate
- Infinitely variable input speeds—from zero to maximum, in both forward and reverse
- Fluid-linked system, hydrostatic braking
- Transfers power to remote locations without a mechanical power train
- Optimizes engine power and performance depending on the load conditions
- Permits smaller service brakes for more cost-effective vehicle maintenance

##### Applications

- Combines, transit mixer drum drives, timber harvesters, construction equipment, farm tractors, sawmills, mining equipment and many other applications.



## Contents Section B - Motors

### **B1 Geroler / Gerotor Motors**

B1	J2 Series	<i>Eaton / Char-Lynn</i>
B2	H Series	<i>Eaton / Char-Lynn</i>
B3	T Series	<i>Eaton / Char-Lynn</i>
B4	T Series + Parking Brake	<i>Eaton / Char-Lynn</i>
B5	2000 Series	<i>Eaton / Char-Lynn</i>
B6	Delta Series	<i>Eaton / Char-Lynn</i>
B7	4000 Series	<i>Eaton / Char-Lynn</i>
B8	6000 Series	<i>Eaton / Char-Lynn</i>
B9	10000 Series	<i>Eaton / Char-Lynn</i>
B10	Seal Kits	<i>Eaton / Char-Lynn</i>
B11	MGG Series	<i>Gresen</i>

### **B12 Gear Motors**

B12	Group 2 Start Motors	<i>Galtech</i>
B13	Group 3 Start Motors	<i>Galtech</i>

### **B14 Piston Motors – Fixed Displacement H.D.**

B14	HD Series	<i>Eaton</i>
-----	-----------	--------------

### **B15 Piston Motors - Radial**

B15	MS Series	<i>Poclairn Hydraulics</i>
B15	MSE Series	<i>Poclairn Hydraulics</i>

### **B16 Piston Motors - Axial**

B16	A2FM Series	<i>Bosch Rexroth</i>
-----	-------------	----------------------



## Geroler Motors - J2 Series – Eaton / Char-Lynn



### Specifications - J2 Series

Displacement	cc/rev	8.2	12.9	19.8	31.6	50.0
Max. Speed*	rpm	1992	1575	1043	650	393
Flow cont.	lpm	17	21	21	21	21
Torque*	Nm	16	25	38	50	62
Pressure $\Delta$ bar**	bar	220	220	220	190	150

\* @ max continuous flow and max. continuous pressure.

\*\* Max peak pressure @ motor inlet port of **220 bar** without regard to  $\Delta$ bar and/or back pressure ratings

- $\Delta$ bar - true pressure difference between inlet and outlet port.

### J2 Series - 5/8" Parallel Shaft - 9/16" UN - Rear Ports

Model	Displacement cc/rev
129-0001	8.2
129-0002	12.9
129-0003	19.8
129-0004	31.6
129-0411	50.0

#### J2 Series Features & Benefits

- Integrated check valves helps extend seal life
- Self-lubricating bushing reduces shaft friction
- Lengthened spool valve lands – higher efficiency operation
- More rigid components helps reduce internal leakage
- Shaft seal - withstand high back pressures
- Corrosion protection - hostile environments

#### Applications

- Agricultural augers, harvesters, seeders
- Railroad maintenance equipment
- Machine tools
- Industrial sweepers and floor polishers
- Conveyors

#### Configuration Options

11/16" Parallel Shaft
16 mm Parallel Shaft
Nickel Plated Shaft
3/8" BSP Rear Ports
9/16" UN O-Ring Side Ports
2 Bolt SAE A-A Mount

## Gerotor Motors - H Series - Eaton / Char-Lynn



### Specifications - H Series

Displacement	cc/rev	36	46	59	74	97	120	146	159	185	231	293	370
Max. Speed*	rpm	1021	969	953	760	585	469	385	353	304	243	192	152
Flow	lpm	38	45	57	57	57	57	57	57	57	57	57	57
Torque*	Nm	56	73	91	118	155	192	221	233	265	302	351	407
Press. Δbar**	bar	124	124	124	124	124	124	117	114	110	100	93	86

\* @ max continuous flow and max. continuous pressure.

\*\* Max intermittent pressure @ motor inlet port of **172 bar** without regard to Δbar and/or back pressure ratings.

- **A simultaneous maximum torque and maximum speed is NOT recommended.**
- 6B splined or tapered shafts are recommended whenever operating above 282 Nm of torque, especially for those applications subject to frequent reversals.
- **Maximum case pressure - without case drain - 103 bar.**
- Δbar - true pressure difference between inlet and outlet port.

### H Series- 2 Bolt Mount, 1" Parallel Shaft, 7/8" UN Ports

Model	Displacement cc/rev
101-1700	36
101-1033	46
101-1701	59
101-1034	74
101-1035	97
101-1702	120
101-1703	146
101-1036	159
101-1037	185
101-1038	231
101-1039	293
101-1040	370

#### H Series Features & Benefits

- Time-tested Char-Lynn drive set
- Three moving components (gerotor-star, drive, and shaft) – reliable performance
- Optimised drive running angle – high efficiency
- Variety of displacements, shafts and mounts – design flexibility
- Three-zone pressure design (inlet, return and case) - extended leak-free performance

#### Applications

- Agricultural augers, harvesters, seeders
- Railroad maintenance equipment
- Machine tools
- Industrial sweepers and floor polishers
- Conveyors

#### Configuration Options

- 4 bolt standard mount
- 2 bolt SAE 'B' mount
- Manifold ports
- 1/2" BSP ports - 'O'-Ring
- End ported with 3/4" UNO ports
- 1/4" BSP case drain end cap
- 7/16" UNO case drain end cap
- 1" x 6B Spline shaft
- 7/8" x 13T Spline shaft
- 25 mm metric parallel shaft
- 1" - 1:8 Taper shaft
- 1" Parallel shaft -nickel plated - for harsh environments
- Epoxy coated marinised
- Low speed valve
- Speed sensor
- Free running

## Geroler Motors - T Series - Eaton / Char-Lynn



### Specifications - T Series

Displacement	cc/rev	36	46	66	80	102	131	157	195	244	306	370
Max. Speed*	rpm	1021	906	849	694	550	426	355	287	229	183	152
Flow	lpm	38	45	57	57	57	57	57	57	57	57	57
Torque*	Nm	76	105	138	174	219	251	297	359	410	441	430
Press. $\Delta$ bar**	bar	155	155	155	155	155	138	138	138	127	110	90

\* @ max continuous flow and max. continuous pressure.

\*\* Max intermittent pressure @ motor inlet port of **190 bar** without regard to  $\Delta$ bar and/or back pressure ratings.

- **A simultaneous maximum torque and maximum speed is NOT recommended.**
- 6B splined or tapered shafts are recommended whenever operating above 282 Nm of torque, especially for those applications subject to frequent reversals.
- **Maximum case pressure - without case drain - 103 bar.**
- $\Delta$ bar - true pressure difference between inlet and outlet port.

### T Series - 2 Bolt Mount, 1" Parallel Shaft, 7/8" UN Ports

Model	Displacement cc/rev
158-3024	36
158-2917	49
158-1537	66
158-1034	80
158-1035	102
158-1538	131
158-1036	157
158-1037	195
158-1038	244
158-1039	306
158-1040	370

#### T Series Features & Benefits

- Constant clearance geroler, geometry – high efficiency
- Optimized drive system with reduced running angle - smooth low-speed operation
- Three-pressure zone design (ability to reduce case pressure) - extended motor life (especially at low speed conditions)
- Variety of displacements, shafts and mounts

#### Applications

- Agricultural augers, harvesters, seeders
- Railroad maintenance equipment
- Machine tools
- Industrial sweepers and floor polishers
- Conveyors
- Turf equipment

#### Configuration Options

- 4 bolt standard mount
- 2 bolt SAE 'B' mount
- 1/2" BSP ports -'O'-ring
- Manifold ports
- 1/4" BSP case drain end cap
- 7/16" UNO case drain end cap
- 1" x 6B Spline shaft
- 7/8" x 13T Spline shaft
- 7/8" Parallel shaft
- 1" Parallel shaft - nickel plated
- 1:8 Taper shaft
- 25 mm Metric parallel shaft
- Low speed
- Epoxy coated marinised
- Speed sensor
- Free running



## Geroler Motors - T Series with Parking Brake Eaton / Char-Lynn

### Specifications - T Series With Parking Brake

Displacement	cc/rev	80	157	244
Max. Speed*	rpm	694	355	229
Flow	lpm	57	57	57
Torque*	Nm	174	297	410
Press. Δbar**	bar	155	138	127

\* @ max continuous flow and max. continuous pressure.

\*\* Max intermittent pressure @ motor inlet port of **190 bar** without regard to Δbar and/or back pressure ratings.

- **A simultaneous maximum torque and maximum speed is NOT recommended.**
- **Minimum brake release pressure 17 bar, maximum release pressure 103 bar.**
- 6B splined or tapered shafts are recommended whenever operating above 282 Nm of torque, especially for those applications subject to frequent reversals.
- **Maximum case pressure - without case drain - 103 bar.**
- Δbar - true pressure difference between inlet and outlet port.

### T Series - 2 Bolt Mount, 1" Parallel Shaft, 7/8" UN Ports

Model	Displacement* cc/rev
185-2002	80
185-2005	157
185-2007	244
185-2008	306

\* Other displacements are available on indent – *Contact Hyspecs*

#### T Series Parking Brake Features & Benefits

- Performance-matched system=> load-holding capacity tailored to match motor
- Configuration capability of combining 4 inventory items into a single assembly (motor, brake, counter-balance valve, brake release line)
- Access port for manual brake release (for overriding brake in the event of loss of release pressure.)
- Rear-mounted integrated brake with 6:1 torque advantage - cost-effective

#### Applications

- Truck-mounted equipment
- Marine cranes
- Fishing winches
- Vehicle recovery winches
- Anywhere load-holding is needed in a low-speed high-torque drive system

#### Configuration Options

4 bolt standard mount
2 bolt SAE 'B' mount
1/2" BSP ports -'O'-ring
Manifold ports
1/4" BSP case drain end cap
7/16" UNO case drain end cap
1" x 6B Spline shaft
7/8" x 13T Spline shaft
7/8" Parallel shaft
1" Parallel shaft - nickel plated
1:8 Taper shaft
25 mm Metric parallel shaft
Low speed
Epoxy coated marinised
Speed sensor
Free running

## Geroler Motors - 2000 Series - Eaton / Char-Lynn



### Specifications - 2000 Series

Displacement	cc/rev	80	100	130	160	195	245	305	395	490
Max. Speed*	rpm	799	742	576	477	385	308	246	191	153
Flow	lpm	75	75	75	75	75	75	75	75	75
Torque*	Nm	235	295	385	455	540	660	765	775	845
Press. Δbar**	bar	205	205	205	205	205	205	205	155	120

\* @ max continuous flow and max. continuous pressure.

\*\* Max intermittent pressure @ motor inlet port of **310 bar** without regard to Δbar and/or back pressure ratings.

- Maximum torque for 1" diameter shaft = 395 Nm continuous.
- To assure optimum motor life, run motor for approximately one hour at 30% of rated pressure before application of full load.
- **Maximum case pressure - without case drain - 140 bar.**
- Δbar - true pressure difference between inlet and outlet port.

### 2000 Series, 2 Bolt SAE A Mount, 1 1/4" Parallel Shaft, 7/8"UN Ports

Model	Displacement cc/rev
104-1022	80
104-1023	100
104-1024	130
104-1025	160
104-1026	195
104-1027	245
104-1028	305
104-1228	395
104-1420	490

Configuration Options
4 bolt wheel mount
2 bolt std SAE B
4 bolt std. square mount
Magneto 4 bolt mount
1/2" BSP ports - O-ring
1 1/16"UN ports
End ported with 7/8" UNO ports
Manifold port mount - 0.375-16 mtg. holes
7/8"UN end ports
1 1/4" Tapered shaft
1" Parallel shaft
1" x 6B Spline shaft
1 1/4" x 14T 12/24 spline shaft
1 1/4" Parallel shaft - chrome plated
1" Parallel shaft - chrome plated
32 mm Metric parallel shaft
7/8" x 13T Spline shaft
2 Speed Motor
Bearingless
Speed sensor

#### 2000 Series Features & Benefits

- Three zone design for longer life and true bi-directionality.
- Bearings that meet the highest standards of the industry - reliability and performance in tough application

#### Applications

- Skid Steer Attachments
- Swing Motor
- Brush Cutters & Mowers
- Augers
- Harvesting Equipment and much more

## Geroler Motors – Delta Series – Eaton/Char-Lynn



### Specifications - Delta Series

Displacement	cc/rev	113	146	198	234	252	300	347	395	470	542	649	754
Max. Speed*	rpm	668	519	382	323	300	252	218	192	161	140	117	100
Flow	lpm	75	75	75	75	75	75	75	75	75	75	75	75
Torque*	Nm	320	429	554	651	712	844	933	972	1039	994	1028	985
Press. Δbar**	bar	205	205	205	205	205	205	205	190	170	140	120	105

\* @ max continuous flow and max. continuous pressure.

\*\* Max intermittent pressure @ motor inlet port of **310 bar** without regard to Δbar and/or back pressure ratings.

- To assure optimum motor life, run motor for approximately one hour at 30% of rated pressure before application of full load.
- When pressurising B port, all displacements have a continuous rating of 2000 psi.
- Δbar - true pressure difference between inlet and outlet port.

### Delta Series 6 Bolt SAE A Mount, 1 1/4" Parallel Shaft, 7/8" UN Ports

Model	Displacement cc/rev
184-0093	113
184-0170	146
184-0171	198
184-0094	234
184-0095	252
184-0130	300
184-0096	347
184-0239	395
184-0213	470
184-0240	542
184-0185	649
184-0065	754

#### Delta Series Features & Benefits

- Proven disc valve technology with the highest efficiencies in its class
- Leak resistant motor with the front bearing protecting the shaft seal
- Perfect replacement for Parker® TF-TG and White™ RE motors
- Lowest no load pressure drop which leads to longer life and lower temperature operation

#### Applications

- Scissor Lift
- Boom Lift
- Brush Cutters & Mowers
- Industrial Sweeper

#### Configuration Options

- Wheel Mount
- 1.5" Straight Shaft
- 1 1/4" Tapered Shaft
- 1 1/4" 14T Spline Shaft
- 1 1/4" Straight Shaft
- 32 mm Straight Shaft
- 1" Straight Shaft

## Geroler Motors - 4000 Series - Eaton / Char-Lynn



### Specifications - 4000 Series

Displacement	cc/rev	110	130	160	205	245	310	395	495	625
Max. Speed*	rpm	697	722	582	459	383	303	239	191	151
Flow	lpm	75	95	95	95	95	95	95	95	95
Torque*	Nm	320	375	485	600	705	850	930	945	970
Press. Δbar**	bar	205	205	205	205	205	205	185	140	115

\* @ max continuous flow and max. continuous pressure.

\*\* Max intermittent pressure @ motor inlet port of **310 bar** without regard to Δbar and/or back pressure ratings.

- Maximum torque for 1 1/4" diameter shaft = 770 Nm continuous.
- To assure optimum motor life, run motor for approximately one hour at 30% of rated pressure before application of full load.
- **Maximum case pressure - without case drain - 105 bar.**
- Δbar - true pressure difference between inlet and outlet port.

### 4000 Series, 4 Bolt SAE B Mount, 1 1/4" Parallel Shaft, 1 1/16" UN Ports

Model	Displacement cc/rev
109-1100	110
109-1101	130
109-1102	160
109-1103	205
109-1104	245
109-1105	310
109-1106	395
109-1212	495
109-1215	625

#### 4000 Series Features & Benefits

- 10 displacements, a variety of mounting flanges and output shafts
- Reliable, proven design
- High efficiency
- Environmental protection options
- Flexibility in designing this motor into a system
- Options that fit well into tough applications

#### Applications

- Mowing
- Sprayer
- Trencher
- Wood Products
- Auger
- Grapple

#### Configuration Options

- Wheel mount
- 4 bolt mount SAE C
- 3/4" Split flange ports
- 3/4" BSP ports
- 1 1/4" x 14T Spline shaft
- 1 1/2" x 17T Spline shaft
- 1 5/8" Tapered shaft
- 40 mm Parallel shaft
- Two way shuttle
- Bearingless



## Geroler Motors - 6000 Series - Eaton / Char-Lynn



### Specifications - 6000 Series

Displacement	cc/rev	195	245	310	390	490	625	985
Max. Speed*	rpm	775	615	485	387	307	241	153
Flow	lpm	150	150	150	150	150	150	150
Torque*	Nm	575	735	930	1155	1445	1380	1685
Press. Δbar**	bar	205	205	205	205	205	140	140

\* @ max continuous flow and max. continuous pressure.

\*\* Max intermittent pressure @ motor inlet port of **310 bar** without regard to Δbar and/or back pressure ratings.

- Maximum torque for 1 1/2" diameter shaft = 1325 Nm continuous.
- To assure optimum motor life, run motor for approximately one hour at 30% of rated pressure before application of full load.
- **Maximum case pressure - without case drain - 105 bar.**
- Δbar - true pressure difference between inlet and outlet port.

### 6000 Series, 4 Bolt SAE 'C-C' Mount, 1 1/2" Parallel Shaft, 1 5/16" UN Ports

Model	Displacement cc/rev
112-1064	195
112-1065	245
112-1066	310
112-1067	390
112-1068	490
112-1107	625
112-1069	985

#### 6000 Series Features & Benefits

- 9 displacements available
- Presents a multitude of options that make this motor very "smart" and flexible to apply
- Very tough motor for demanding applications
- Can be used in a multitude of industries
- Very easy/flexible to integrate in a system

#### Applications

- Mobile equipment
- Mowing, Sprayer, trencher
- Wood products
- Auger
- Grapple
- Harvesting equipment

#### Configuration Options

Wheel mount
3/4" Split flange ports
1" BSP ports
1 1/2" x 17T Spline shaft
1 3/4" Tapered shaft
40 mm Metric parallel shaft
Bearingless



## Geroler Motors - 10000 Series - Eaton / Char-Lynn



### Specifications - 10000 Series

Displacement	cc/rev	345	480	665	940
Max. Speed*	rpm	501	354	254	179
Flow	lpm	170	170	170	170
Torque*	Nm	1040	1475	2085	2700
Press. Δbar**	bar	205	205	205	190

\* @ max continuous flow and max. continuous pressure.

\*\* Max intermittent pressure @ motor inlet port of **275 bar** without regard to Δbar and/or back pressure ratings.

- To assure optimum motor life, run motor for approximately one hour at 30% of rated pressure before application of full load.
- **Maximum case pressure - without case drain - 20 bar.**
- Δbar - true pressure difference between inlet and outlet port.

### 10000 Series 4 Bolt Standard Mount, 2 1/4" Parallel Shaft, 1 5/16" UN Ports

Model	Displacement cc/rev
119-1028	340
119-1029	480
119-1030	665
119-1031	940

#### 10000 Series Features & Benefits

- High torque and flow
- Many options like 2 speed and speed sensors make this motor "smart"
- Low pressure loss even in higher flows
- High power density for demanding mobile and industrial applications
- Many options to draw from

#### Applications

- Boring / Auger
- Industrial
- Metal Forming
- Port Equipment
- Saw Mill
- Harvesting Equipment

#### Configuration Options

Wheel Mount

1 1/4" Split Flange Ports

2 1/8" X 16t Spline Shaft

2 1/4" Tapered Shaft

2 Speed

#### Also Available As 2 Speed Motors (1:2)

- Shifts the motor from a low speed, high torque to a high speed, low torque mode.
- The open centre selector valve shifts the speed mode from low to high speed when pilot pressure is applied to the pilot port. The pilot pressure should be at least 7 bar higher than the case pressure.
- In the high-speed mode torque values are approx. one half with twice the speed of a conventional 10000 series single speed motor.
- Normal position of the motor is in the low speed mode

## Gerotor/Geroler Motors - Seal Kits - Eaton / Char-Lynn



Series	Shaft Seal*	Seal Kit
<b>J-Series</b>		
129-XXXX-002	14709-002	60580-000
<b>H-Series</b>		
101-XXXX-005	20599-000	60036-000
101-XXXX-007	9057-001	60023-000
101-XXXX-008/009	9057-014	60540-000
<b>S-Series</b>		
103-XXXX-006	20599-000	60042-000
103-XXXX-007	9057-001	60026-000
103-XXXX-008	9057-001	60533-000
103-XXXX-009/010	9057-014	60539-000
<b>T-Series</b>		
158-XXXX-001	9057-014	60564-000
185-XXXX-001	9057-014	60564-000
<b>W-Series</b>		
162-XXXX-004	9057-009	60577-000
<b>2000-Series</b>		
104-XXXX-005	9057-009	61252-000
105-XXXX-005		
106-XXXX-005		
104-XXXX-006	9057-009	61258-000
105-XXXX-006		
106-XXXX-006		61259-000
<b>3000-Series</b>		
107-XXXX-004		6099-000
<b>4000 Compact Series</b>		
169-XXXX-001	9057-009	61333-000 (small shaft)
	9057-012	61353-000 (large shaft)
<b>Delta Series</b>		
184-XXXX-002		9900436-000
<b>4000-Series</b>		
109-XXXX-004	9057-012	61234-000 (Rear)
110-XXXX-004		61236-000 (Shaft)
109-XXXX-006	9057-012	61234-000 (Rear)
110-XXXX-006		61281-000 (Shaft)
111-XXXX-004/005		61235-000 (Bearingless)
<b>6000-Series</b>		
112-XXXX-005/006	9057-013	61237-000 (Shaft)
113-XXXX-005/006		61238-000 (Rear)
114-XXXX-005/006	9057-013	61239-000 (Bearingless)
<b>10000-Series</b>		
119-XXXX-002/003/004	9004-002	6405-000 (Rear)
120-XXXX-002/003/004		6406-000 (Front)

\* Shaft seal only. Does not include backup washer or dust seal if needed.

## Gerotor High Speed Motors - Gresen



### MGG Series

Displacement	cc/rev	3.6	6.1	7.4	9.5	11.5
Max. Speed	rpm	5000	5000	5000	5000	5000
Flow*	lpm	22	35	42	52	63
Torque*	Nm	6.8	11.8	15.8	19.2	24.9
Press. Δbar	bar	138	138	138	138	104
Power Output*	kW	3	4	7	9	11

\* @ max. continuous flow and max. continuous pressure

- **Maximum back pressure = 68 bar.**
- All MGG20010, MGG20016, MGG20020 motors have 3/4-16 UNF Ports.
- All MGG20025, MGG20030 motors have 7/8-14 UNF Ports.
- All MGG motors have a 9/16" parallel, keyed shaft.

### Gresen MGG Gerotor Motors

Model	Displacement cc/rev
MGG20010 B * 1 ^ 3	3.6
MGG20016 B * 1 ^ 3	6.1
MGG20020 B * 1 ^ 3	7.4
MGG20025 B * 1 ^ 3	9.5
MGG20030 B * 1 ^ 3	11.5

\* Flange : 'A' designates 2 Bolt SAE AA  
'B' designates 4 Bolt, to suit M8 bolts on a 50.8 mm PCD, 45.28 mm spigot

^ Port Locations: 'A' designates 2 Rear Ports  
'B' designates 2 Side Ports

#### MGG Motors Features & Benefits

- Gerotor design (high speed, low torque)
- Aluminum construction for optimum power to weight ratio
- Bi-directional
- High-pressure mechanical seals available for series application to 1000 PSI back pressure
- Roller bearings for long life
- Buna-N Seals are standard for petroleum and glycol based fluids.
- MGG — Motor - Shaft speeds to 5000 RPM
- Up to 17 HP output for motors

## Gear Motors - Galtech



### Group 2 'Start' Motors.

- 12 tooth gears and consequent decrease in noise levels.
- High working pressures.
- Flange and cover in aluminium or on request, cast iron (higher pressures).
- Bi-directional motors with bronze teflon bushings for heavy duty, non-dusty environments where noise levels must be kept down.
- Euro-mount - 96.2 mm x 71.5 mm rectangular, spigot Ø36.5 mm, 1:8 taper shaft & flanged ports.

Model	Displacement <i>cc/rev</i>	Max. Cont. Pressure <i>bar</i>	Max. Speed <i>rpm</i>
2SM-A-040-R-EUR-K-N-10-0-N	4.0	210	4000
2SM-A-060-R-EUR-K-N-10-0-N	6.0	210	4000
2SM-A-080-R-EUR-K-N-10-0-N	8.5	210	3500
2SM-A-110-R-EUR-K-N-10-0-N	11.0	210	3500
2SM-A-140-R-EUR-K-N-10-0-N	14.0	210	3500
2SM-A-160-R-EUR-K-N-10-0-N	16.5	195	3500
2SM-A-190-R-EUR-K-N-10-0-N	19.5	180	3300
2SM-A-220-R-EUR-K-N-10-0-N	22.5	160	2800
2SM-A-260-R-EUR-K-N-10-0-N	26.0	145	2500

Accessories	Description
FG 3/4-40	Port flange, 90° elbow, 3/4" BSP, 40 PCD, 11-26 cc/rev
FG 1/2-30	Port flange, 90° elbow, 1/2" BSP, 30 PCD, 4-8 cc/rev
FG 1/2-40	Inlet & Outlet flange, 90° elbow, 1/2" BSP, 40 PCD
FI 40-1/2-Z-C	Port flange, straight port, 1/2" BSP, 40 PCD, 11-26 cc/rev
FI 30-3/8-Z-C	Port flange, straight port, 3/8" BSP, 30 PCD, 4-8 cc/rev

**N.B. - Please consult Hyspecs concerning series applications using gear motors.**

#### Group 2 'Start' Motors Features & Benefits

- Aluminum gear motor, bi-directional
- 12 tooth gears and consequent decrease in noise levels.
- High working pressures.

#### Configuration Options

Shaft type	1:8 Taper shaft – 10
	5/8" Parallel keyed shaft – 13
Mounting flange type	Standard Euro-mount 96.2 mm x 71.5 mm rectangle
	SAE 'A' Two bolt mount

## Gear Motors – Galtech



### Group 3 ‘Start’ Motors.

- 12 Tooth gears and consequent decrease in noise levels.
- High working pressures.
- Flange and cover in cast iron.
- Bi-directional motors with bronze teflon bushings for heavy duty, non-dusty environments where noise levels must be kept down.
- Euro-mount, - 128 mm x 98 mm, spigot Ø50.8 mm, 1:8 taper shaft & flanged ports.

Model	Displacement cc/rev	Max. Cont. Pressure bar	Max. Speed rpm
3GM-G-190-R-EUR-K-N-10-0-N	19.3	215	3500
3GM-G-230-R-EUR-K-N-10-0-N	23.0	215	3500
3GM-G-300-R-EUR-K-N-10-0-N	30.2	205	3300
3GM-G-340-R-EUR-K-N-10-0-N	33.8	205	3300
3GM-G-370-R-EUR-K-N-10-0-N	37.5	195	3300
3GM-G-440-R-EUR-K-N-10-0-N	44.6	190	3000
3GM-G-530-R-EUR-K-N-10-0-N	53.0	180	3000
3GM-G-620-R-EUR-K-N-10-0-N	62.7	160	2500

Accessories	Description
FG 1-51	Port flange, 90° elbow, 1” BSP, 51 PCD
FI 40-1/2-Z-C	Port flange, straight port, 1/2” BSP, 40 PCD

**N.B. - Please consult Hyspecs concerning series applications using gear motors.**

#### Group 3 ‘Start’ Motors Features

- Aluminum gear motor, bi-directional
- 12 tooth gears and consequent decrease in noise levels.
- High working pressures.

#### Configuration Options

Shaft type	1:8 Taper shaft – 10
	7/8” Parallel keyed shaft – 13
Mounting flange type	Standard Euro-mount 128 mm x 98 mm rectangle
	SAE ‘B’ Two bolt mount

## Piston Motors - Fixed Displacement H.D. - Eaton

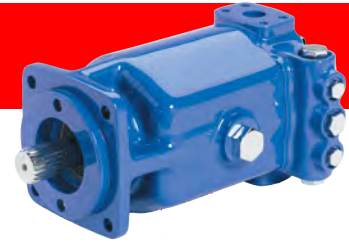

### HD Series

Model		39	46	54	64	76
Displacement	cc/rev	63.7	75.3	89.1	105.5	124.8
Max. Speed @ 18° Cam Angle	rpm	4160	4160	3720	3720	2775
Max. Flow	lpm	231	332	337	409	371
Max. Torque**	Nm	397	469	556	656	781
Press. Δbar	bar	240	240	240	240	240
Power Output	kW	125	150	155	185	164

\* At 15.5° cam angle

\*\* Maximum output torque is measured @ 415 bar

Model	Displacement cc/rev
3933-XXX	63.7
4633-XXX	75.3
5433-XXX	89.1
6433-XXX	105.5
7630-XXX	124.8

XXX - Identifies specific unit configuration - **Consult Hyspecs**

- **Variable displacement units also available on request.**

### Piston Motors – Fixed Displacement H.D. Series – Features & Benefits

- High strength cast iron housings – provide greater noise damping and wall strength.
- Cartridge shaft seal – lends itself to easy serviceability. Mechanical face seal design tolerates high speed and high case pressures.
- Pistons – have long engagement with cylinder bore resulting in low leakage.
- Fixed clearance slipper hold down – on Models 39 through 64 allows operation at high speed and reduces friction.
- End cover – large passages minimises losses. Both side and rear ports are available on Models 39 through 64 fixed motors.

## Piston Motors - Radial – Poclain Hydraulics



### MS Series

- Hydraulic shaft motors: multi-cam radial pistons. Standard manufacture splined shaft (DIN), one or two speeds, with or without brake (integral multi-disc wet brake).
- Also available as a hydraulic wheel motor with flanged output shaft or drum brake on some models.
- **Contact Hyspecs for pricing.**

### Specification – MS Series

Model		MS02	MS05	MS08	MS11	MS18	MS25	MS35	MS50	MS83	MS125
Displacement	cc/rev	213	468	780	1048	1747	2498	3494	4996	8323	12500
Max. Speed	rpm	310	240	170	180	150	140	130	135	60	40
Max. Torque*	Nm	1845	4005	6682	9000	15030	21510	30060	43065	71775	76320
Press. $\Delta$ bar**	bar	450	450	450	450	450	450	450	450	450	450
Power Output	kW	18	29	41	50	70	90	110	140	200	240

\* Theoretical maximum torque at maximum pressure and largest displacement

\*\* Depending on selected displacement

- Intermediate displacements are available – *Contact Hyspecs*

### MSE Series

- Some MS Series are available with larger displacements in smaller bodies (MSE series) to give a compact design. This results in lower pressures and speeds.

### Specification – MSE Series

Model		MSE02***	MSE05	MSE08	MSE11	MSE18
Displacement	cc/rev	332	625	1050	1404	2340
Max. Speed	rpm	200	180	130	135	110
Max. Torque*	Nm	2500	4760	7900	10740	17840
Press. $\Delta$ bar**	bar	400	400	400	400	400
Power Output	kW	22	29	41	50	70

\* Theoretical maximum torque at maximum pressure and largest displacement

\*\* Depending on selected displacement

\*\*\* Single displacement only

- Intermediate displacements are available – *Contact Hyspecs*

#### Poclain Hydraulics MS & MSE Motor Features & Benefits

- Low speed, high torque, high efficiency motors.
- Many options like Intergrated Anti-Skidding (Twin-Lock) and speed sensors make this motor “smart”.
- Low pressure loss even in higher flows.
- High power density for demanding mobile and industrial applications.

#### Applications

- Boring / Auger
- Winches, slews, conveyors
- Port Equipment
- Wheel Drives
- Harvesting Equipment
- Industrial plant

## Piston Motors – Axial – Bosch Rexroth



### A2FM Series – Fixed Displacement Axial Motor

- For open and closed circuits
- Sizes 5 to 1000 cc/rev
- Nominal pressure 400 bar, Maximum pressure 450 bar
- Metric mount

#### Features

- Fixed displacement motor A2FM of axial piston, bent axis design, suitable for hydrostatic drives in open and closed circuits
- Use in mobile and industrial applications
- Output speed is proportional to input flow and inversely proportional to displacement
- Drive torque increases with the pressure drop across the unit
- Careful selection of the displacements offered, permit sizes to be matched to practically every application
- Favourable power / weight ratio
- Compact design
- Optimum efficiency
- Economical conception
- One-piece pistons with piston rings

#### Technical data

Max Displacement*	cc/rev	23	45	63	80
Max. Speed	rpm	6300	5600	5000	4500
Max. Flow**	lpm	144	255	315	360
Press. Δbar	bar	400	400	400	400
Cont. Inlet Temp	°C	82	82	82	82
Mounting Flange		4-Bolt ISO	4-Bolt ISO	4-Bolt ISO	4-Bolt ISO

\* Different displacements available on request (Sizes 5 to 1000 cc/rev).



## Contents Section C - Hydrostatics

### **C1 Transmission – Light Duty**

C1 Model 7 Transmission

*Eaton*

## Transmissions - Light Duty - Eaton

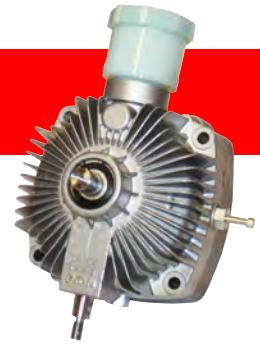

### Light Duty Pump – Motor Combo Series

Model		Model 7
Max Displacement – Pump	<i>cc/rev</i>	7.6
Displacement – Motor	<i>cc/rev</i>	12.6
Max. Speed - Input	<i>rpm</i>	3600
Max. Speed - Output	<i>rpm</i>	0 - 2150
Max. Power – Input*	<i>kW</i>	3
Max. Torque – Output	<i>Nm</i>	25
Max. Operating Temperature	<i>°C</i>	82

- @ max continuous input speed

### Model 7

Model	Rotation Input	Rotation Output	Input Shaft	Output Shaft	Dump Valve
700-001	CCW	CW	Parallel keyed	Parallel keyed	Yes
700-003	CW	CCW	Parallel keyed	Parallel keyed	Yes

- **Proper cooling is essential to both the performance and the life of these transmissions.**
- The recommended max. oil temperature is 82°C. A Ø205 mm fan must be attached to the coupling at the input shaft to blow air across the finned cover, or use an external oil cooler.

Fans	
106014-000	Light duty fan. CW - rotation
106015-000	Light duty fan. CCW - rotation

### Model 7

#### Features & Benefits

- Consists of a variable displacement radial ball piston pump, a fixed displacement radial ball piston motor and a system of valves all contained in one housing.
- These transmissions give fast response and are capable of maintaining precise speed under varying load conditions.
- One lever controls direction and speed smoothly without gear change. This lever also provides braking. The output shaft speed decreases as the lever is moved toward neutral. With the lever in neutral, output stops.
- All-in-one design simplifies product by eliminating complex linkages, leaks from external lines, external high pressure lines and separate drive components.
- Model 7 expands on the Model 6 but delivers significant noise level reductions under high torque or load conditions. Rated to 3kW @ 3600 RPM input.

## Contents Section D – Control Valves

### D1 Manual Valves

D1	Q25M	<i>Galtech</i>
D2	Q45M	<i>Galtech</i>
D3	Q75M	<i>Galtech</i>
D4	Q95M	<i>Galtech</i>
D5	LS (Log Splitter) Series	<i>Brand Hydraulics</i>
D5	SDCF Proportional Series	<i>Brand Hydraulics</i>

### D6 Solenoid Valves & Accessories

D6	Cetop Manifold Sub-Plates - How to Order	<i>Hyspecs</i>
D7	Cetop 3 Sub-Plates	<i>Hyspecs</i>
D7	Cetop 5 Sub-Plates	<i>Hyspecs</i>
D8	Cetop 3	<i>Northman</i>
D9	Cetop Spool & Solenoid Configuration	<i>Northman</i>
D10	Cetop 3 Modules	<i>Northman</i>
D11	Cetop 5	<i>Northman</i>
D12	Cetop 5 Modules	<i>Northman</i>
D13	Cetop 3	<i>Eaton/Vickers</i>
D16	Cetop Spool & Solenoid Configuration	<i>Eaton/Vickers</i>
D17	Cetop 3 Systemstak Modules	<i>Eaton/Vickers</i>
D18	Cetop 5	<i>Eaton/Vickers</i>
D20	Cetop 5 Systemstak Modules	<i>Eaton/Vickers</i>
D21	Cetop 7	<i>Eaton/Vickers</i>
D22	Cetop 8	<i>Eaton/Vickers</i>
D23	Cetop 3 / 5	<i>Bosch Rexroth</i>

### D24 Proportional Cetop Valves

D24	Directional, Relief & Throttle	<i>Eaton/Vickers</i>
D25	Proportional Cetop Accessories	<i>Eaton/Vickers</i>

### D26 Proportional Sectional Valves

D26	DLS 7	<i>Walvoil</i>
D27	DPC130 Select Inlet & Options	<i>Walvoil</i>
D29	DPC130 Select Working Sections	<i>Walvoil</i>
D31	DPC130 Select Outlet	<i>Walvoil</i>
D33	DPC200	<i>Walvoil</i>
D34	PVG32	<i>Danfoss</i>

### D44 Diverter / Selector Valves

D44	Rotary & Push Pull 3 & 6 Port	<i>Walvoil</i>
D45	Electric 3, 6 & 8 Port	<i>Poclain Hydraulics</i>
D46	Electric 6 Port	<i>Walvoil Hydraulics</i>

## Contents Section D – Control Valves

### D47 Flow Control Valves

D47	Manual 3 Port P/C Flow Control	<i>Brand Hydraulics</i>
D48	2 Port, High Pressure Needle Valve	<i>Tognella</i>
D48	2 Port, High Pressure, FRF, Needle Valve	<i>Tognella</i>
D48	2 Port, P/C, FRF, Flow Control	<i>Tognella</i>
D49	2 Port, Brass Forged Needle Valve	<i>Tognella</i>
D49	2 Port, Brass Forged, FRF Needle Valve	<i>Tognella</i>
D49	2 Port, 90°, Brass Forged Needle Valve	<i>Tognella</i>
D49	2 Port, 90°, Brass Forged, FRF N/Valve	<i>Tognella</i>

### D50 Gauge Isolators

D50	Needle Type	<i>Tognella</i>
D50	Push Button Type	<i>Tognella</i>

### D50 Stainless Steel Valves

D50	2-Way Ball Valve	<i>Tognella</i>
D50	Needle Valve	<i>Tognella</i>
D50	2-Port PC Flow Control	<i>Tognella</i>

### D51 Ball Valves

D51	Ball Valve – 2 Way	<i>Tognella</i>
D51	Ball Valve – 3 Way	<i>Tognella</i>

### D51 Check Valves

D51	Check Valve – 0.35 Bar Spring	<i>Tognella</i>
D51	Check Valve – 4.5 Bar Spring	<i>Tognella</i>

### D52 Reciprocating Valves

D52	Reciprocating Valve Cetop 5	<i>Poclain Hydraulics</i>
-----	-----------------------------	---------------------------

## Manual Valves - Galtech



### Q25M/\*

- Monoblock valves equipped with load drop check and adjustable relief valve.
- Max. back pressure = 25 bar standard. (180 bar on 1 & 2 bank valves on request)
- 3/8" BSP inlet & cylinder ports, 1/2" BSP tank port.
- Handle can be fitted either end with various orientations.
- **Caution:** Remove load check if using any motor spools with over running loads.
- Optional 12/24 VDC solenoid operation.

Model	Description	Max. Flow <i>lpm</i>	Max. Pressure <i>bar</i>
Q25M/1	1 Spool c/w Relief	40	350
Q25M/2	2 Spool c/w Relief	40	350
Q25M/3	3 Spool c/w Relief	40	320
Q25M/4	4 Spool c/w Relief	40	300
Q25M/5	5 Spool c/w Relief	40	300
Q25M/6	6 Spool c/w Relief	40	300
Q25M/7	7 Spool c/w Relief	40	300
Q25M/8	8 Spool c/w Relief	40	300

Configuration Options	
02566 F6D	Power beyond sleeve.
03600 A1-A2	Handle and bracket
03741 R1	1 position detent kit. Pull lever to detent.
03742 R2	1 position detent kit. Push lever to detent.
03743 R1K	1 position pull to detent. Adjustable hydraulic release. Suitable for a logsplitter.
03743 R2K	1 position push to detent. Adjustable hydraulic release. Suitable for a logsplitter.
03743 R3	3 position detent kit.
03746 R6	2 position detent kit
03748 R8	4th Position float kit.
Z10071L1500	1.5m remote cable.
Z10071L2000	2.0m remote cable.
Z10071L3000	3.0m remote cable.
03637 A15-R	Dual axis lever to fit directly to valve.
03630 SL	Remote lever
03631 SL/A15-DU	Dual axis remote lever.
03715 M1-U2	Cable adapter kit.
03661 P1-N	Pneumatic actuator.
03785 H5	Hydraulic actuator.
02571 103/71	12VDC on/off solenoid kit.
02571 103/72	24VDC on/off solenoid kit.
02567 F16D	Closed Centre Plug Q25

## Manual Valves - Galtech



### Q45M

- Monoblock valves equipped with load drop check and adjustable relief valve.
- Max. back pressure = 25 bar standard. (180 bar on 1 & 2 bank valves on request)
- 1/2" BSP inlet & cylinder ports, 1/2" BSP tank port.
- Handle can be fitted either end with various orientations.
- **Caution:** Remove load check if using any motor spools with over running loads.
- Optional 12/24 VDC solenoid operation.

Model	Description	Max. Flow <i>lpm</i>	Max. Pressure <i>bar</i>
Q45M/1	1 Spool c/w Relief	60	350
Q45M/2	2 Spool c/w Relief	60	350
Q45M/3	3 Spool c/w Relief	60	320
Q45M/4	4 Spool c/w Relief	60	300
Q45M/5	5 Spool c/w Relief	60	300
Q45M/6	6 Spool c/w Relief	60	300
Q45M/7	7 Spool c/w Relief	60	300
Q45M/8	8 Spool c/w Relief	60	300

Configuration Options	
04566 F6D	Power beyond sleeve.
03600 A1-A2	Handle and bracket
03741 R1	1 position detent kit. Pull lever to detent.
03742 R2	1 position detent kit. Push lever to detent.
03743 R1K	1 position pull to detent. Adjustable hydraulic release. Suitable for a logsplitter.
03743 R2K	1 position push to detent. Adjustable hydraulic release. Suitable for a logsplitter.
03743 R3	3 position detent kit.
03746 R6	2 position detent kit
03748 R8	4th Position float kit.
Z10071L1500	1.5m remote cable.
Z10071L2000	2.0m remote cable.
Z10071L3000	3.0m remote cable.
03637 A15-R	Dual axis lever to fit directly to valve.
03630 SL	Remote lever
03631 SL/A15-DU	Dual axis remote lever.
03715 M1-U2	Cable adapter kit.
03661 P1-N	Pneumatic actuator.
03785 H5	Hydraulic actuator.
02571 103/71	12VDC on/off solenoid kit.
02571 103/72	24VDC on/off solenoid kit.
04567 F16D	Closed centre plug Q45

## Manual Valves - Galtech



### Q75M

- Monoblock valves equipped with load drop check and adjustable relief valve.
- Max. back pressure = 25 bar standard.
- 1/2" BSP inlet & cylinder ports, 3/4" BSP tank port.
- Handle can be fitted either end with various orientations.
- **Caution:** Remove load check if using any motor spools with over running loads.
- Optional 12/24 VDC solenoid operation.

Model	Description	Max. Flow <i>lpm</i>	Max. Pressure <i>bar</i>
Q75M/1	1 Spool c/w Relief	80	350
Q75M/2	2 Spool c/w Relief	80	350
Q75M/3	3 Spool c/w Relief	80	300
Q75M/4	4 Spool c/w Relief	80	270
Q75M/5	5 Spool c/w Relief	80	270
Q75M/6	6 Spool c/w Relief	80	270

Configuration Options	
05566 F6D	Power beyond sleeve.
08600 A1-A2	Handle and bracket.
08741 R1	1 position detent kit, Pull lever to detent.
08742 R2	1 position detent kit, Push lever to detent.
08741 R1K-TS	1 position pull to detent. Adjustable hydraulic release. Suitable for a logsplitter.
08742 R2K-TS	1 position push to detent. Adjustable hydraulic release. Suitable for a logsplitter.
08743 R3	3 position detent kit.
08748 R8	4th Position float kit.
Z10071L1500	1.5m remote cable.
Z10071L2000	2.0m remote cable.
Z10071L3000	3.0m remote cable.
08630 SL	Remote lever.
08715 M1-U2	Cable adapter kit.
08661 P1-N	Pneumatic actuator.
08785 H5	Hydraulic actuator.
05571 103/71	12VDC on/off solenoid kit.
05571 103/72	24VDC on/off solenoid kit.
05567 F16D	Closed centre plug Q75.

## Manual Valves - Galtech



### Q95M

- Monoblock valve equipped with load drop check and adjustable relief valve.
- Max. back pressure = 25 bar standard.
- 3/4" BSP inlet & cylinder ports, 3/4" BSP tank port.
- Handle can be fitted either end with various orientations.
- **Caution:** Remove load check if using any motor spools with over running loads.
- Optional 12/24 VDC solenoid operation.

Model	Description	Max. Flow <i>lpm</i>	Max. Pressure <i>bar</i>
Q95M/1	1 Spool c/w Relief	120	350
Q95M/2	2 Spool c/w Relief	120	350
Q95M/3	3 Spool c/w Relief	120	300
Q95M/4	4 Spool c/w Relief	120	270
Q95M/5	5 Spool c/w Relief	120	270
Q95M/6	6 Spool c/w Relief	120	270

Configuration Options	
09566 F6D	Power beyond sleeve.
08600 A1-A2	Handle and bracket.
08741 R1	1 position detent kit. Pull lever to detent.
08742 R2	1 position detent kit. Push lever to detent.
08741 R1K-TS	1 position pull to detent. Adjustable hydraulic release. Suitable for a logsplitter.
08742 R2K-TS	1 position push to detent. Adjustable hydraulic release. Suitable for a logsplitter.
08743 R3	3 position detent kit.
08748 R8	4th Position float kit.
Z10071L1500	1.5m remote cable.
Z10071L2000	2.0m remote cable.
Z10071L3000	3.0m remote cable.
08630 SL	Remote lever.
08715 M1-U2	Cable adapter kit.
08661 P1-N	Pneumatic actuator
08785 H5	Hydraulic actuator.
05571 103/71	12VDC on/off solenoid kit.
05571 103/72	24VDC on/off solenoid kit.
09567 F16D	Closed Centre plug Q95.



## Manual Valves - Brand Hydraulics



### LS Series

- Primarily for log splitters with flows to 68 lpm and 207 bar.
- Designed to spring centre to neutral in one direction and pressure release the detent in the other direction when the cylinder completes its return stroke.
- Available in tandem and closed centre spools.
- LS120 Ports - Inlet and outlet are 1 1/16" UNO and 7/8" UNO work ports.

Model	Description	Max. Flow lpm	Max. Pressure bar
LS120T4JRSH	Tandem centre valve, adjustable detent pressure	68	207
LS120C4JRSH	Closed centre valve, adjustable detent pressure	68	207

### SDCF Proportional Series

- Combines the features of a four-way control valve, an adjustable full range pressure compensated by-pass flow control valve and a pilot operated pressure relief valve in one package.
- Fine positive metering is possible in both directions with one infinitely variable lever controlling both direction and the amount of flow.
- Amount of flow is proportional to the movement of the lever and is constant regardless of pressure variations.
- The valves are 207 bar capable & available with 22 lpm, 45 lpm, & 68 lpm rated spools.
- Available with tandem metering, fine metering and open centre spools.
- Ports - Inlet and outlet are 1 1/16" UN O-Ring and work ports are 7/8" UN O-RING.
- Stainless steel spools are standard.



Model	Description	Max. Flow lpm	Max. Pressure bar
SDCF120TM184GF1	Single section c/w relief 68 lpm spool Ball friction detent	68	207

Configuration Options
Fine metering spool - M
Open centre spool - O
22 lpm spool - 6
45 lpm spool - 12
68 lpm spool - 18
Spring centred - S
3 Position ball detent - D

## Solenoid Valves & Accessories

### Cetop Manifold Sub-Plates - How to Order

- Cartridge valving offers the design engineers and customers an unlimited range of integral circuit design possibilities. With the extensive range of cartridges available, an entire valving system can be housed in one aluminium or steel block, saving on hose and fittings, installation time, and space. Having all of the valves in one block also eliminates possible leakage points, making this system attractive to industries that require total protection from leaks and hydraulic oil contamination.
- Cartridge blocks and valves can be custom designed for a specific application or ordered as an 'off the shelf' item for more common functions.
- Price and delivery for custom designed blocks are available on application.
- **Note:** The cartridge numbers listed in this price list have been abbreviated for simplicity of description. Please consult Hydraulic Specialties for the full cartridge code and cartridge options.
- Hydraulic Specialties has an extensive range of standard CETOP 3 and 5 sub-plates. These are designed to suit the majority of applications. Hydraulic Specialties offers series or parallel configuration for up to 5 stations. Sub-plates are machined for two pressure ranges: - up to 280 bar and 350 bar.

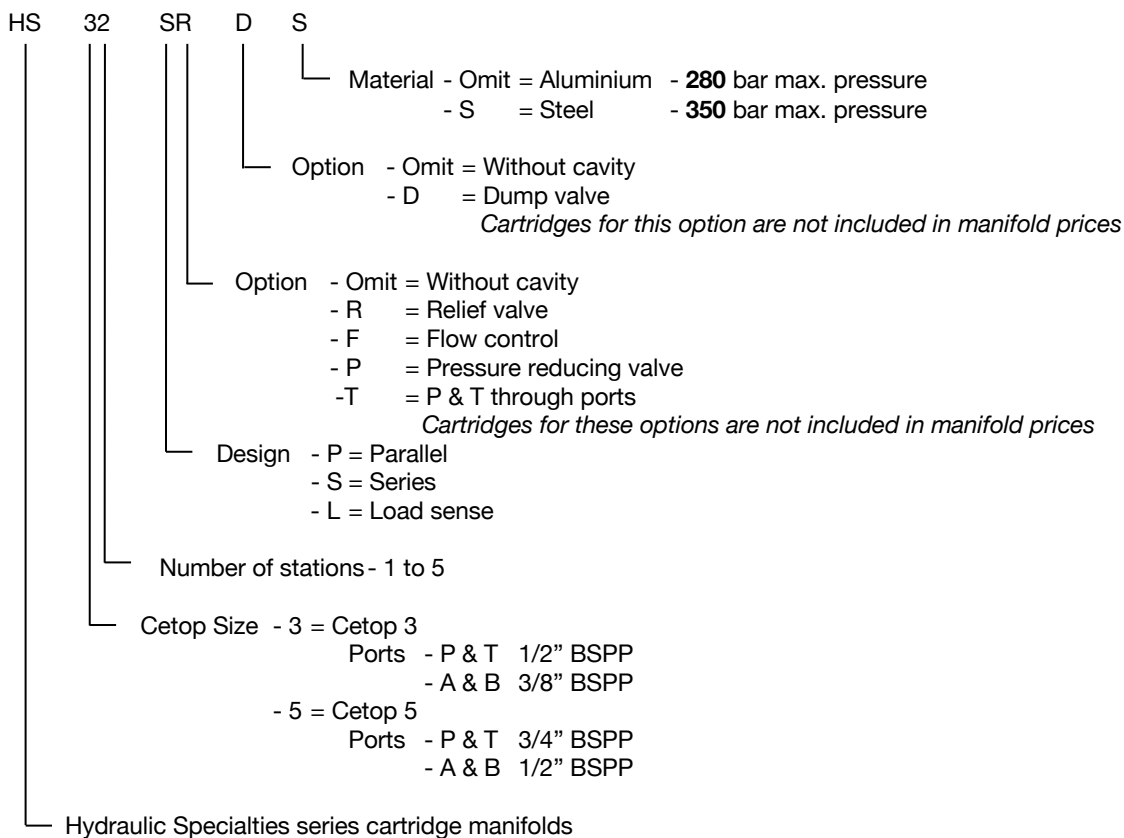

## Solenoid Valves & Accessories



### Cetop 3 Sub-Plates

Block	Description	Stations
HS31PR	Cetop 3, single station, relief cavity, test point	1
HS32PR	Cetop 3, two station, parallel, relief cavity, test point	2
HS32SR	Cetop 3, two station, series, relief cavity, test point	2
HS32LR	Cetop 3, two station, parallel, relief cavity, test point, load sense	2
HS33PR	Cetop 3, three station, parallel, relief cavity, test point	3
HS33SR	Cetop 3, three station, series, relief cavity, test point	3
HS33LR	Cetop 3, three station, parallel, relief cavity, test point, load sense	3
HS34PR	Cetop 3, four station, parallel, relief cavity, test point	4
HS34SR	Cetop 3, four station, series, relief cavity, test point	4
HS34LR	Cetop 3, four station, parallel, relief cavity, test point, load sense	4
HS35PR	Cetop 3, five station, parallel, relief cavity, test point	5
HS35SR	Cetop 3, five station, series, relief cavity, test point	5
HS35LR	Cetop 3, five station, parallel, relief cavity, test point, load sense	5
HS36PR	Cetop 3, six station, parallel, relief cavity, test point	6
HS36SR	Cetop 3, six station, series, relief cavity, test point	6
HS36LR	Cetop 3, six station, parallel, relief cavity, test point, load sense	6
HS37PR	Cetop 3, seven station, parallel, relief cavity, test point	7
HS37LR	Cetop 3, seven station, parallel, relief cavity, test point, load sense	7

\* Other configurations are available on request - *consult Hydraulic Specialties*

\* Sub-plates do not include cartridge valving (relief, check, test points etc.)

### Cetop 5 Subplates

Block	Description	Stations
HS51PR	Cetop 5, single station, relief cavity, test point	1
HS52PR	Cetop 5, two station, parallel, relief cavity, test point	2
HS52SR	Cetop 5, two station, series, relief cavity, test point	2
HS52LR	Cetop 5, two station, parallel, relief cavity, test point, load sense	2
HS53PR	Cetop 5, three station, parallel, relief cavity, test point	3
HS53SR	Cetop 5, three station, series, relief cavity, test point	3
HS53LR	Cetop 5, three station, parallel, relief cavity, test point, load sense	3
HS54PR	Cetop 5, four station, parallel, relief cavity, test point	4
HS54SR	Cetop 5, four station, series, relief cavity, test point	4
HS54LR	Cetop 5, four station, parallel, relief cavity, test point, load sense	4
HS55PR	Cetop 5, five station, parallel, relief cavity, test point	5
HS55SR	Cetop 5, five station, series, relief cavity, test point	5
HS55LR	Cetop 5, five station, parallel, relief cavity, test point, load sense	5
HS56PR	Cetop 5, six station, parallel, relief cavity, test point	6
HS56LR	Cetop 5, six station, parallel, relief cavity, test point, load sense	6

#### Configuration Options

HS CT3 COVER	Cetop 3 blanking cover
HS CT5 COVER	Cetop 5 blanking cover
HS CT5/CT3	Cetop 5 to Cetop 3 adaptor
-	Additional dump valve cavity

## Solenoid Valves & Accessories - Cetop 3 - Northman

### SWH-G02 Series Features

- Oil immersed armatures, impact is cushioned, reduced noise, solenoid life increased.
- Wet armature solenoid eliminates push pin seal, therefore no seal wear or leakage, for longer valve life.
- Moulded coils for maximum insulating properties, which are impervious to dirt and moisture.
- Plug in solenoid for ease of maintenance.
- All spools and bodies are interchangeable.
- High pressure, high flow rating provides low pressure drop with max. performance.
- Balanced spool allows proper shifting force for max reliability and long life.
- Comes with indicating signal light Hirschmann plug/s and single station bolt kit.

### Specifications

Max. tank pressure - 140 bar  
 Max. freq. of operation - 300 cycles per minute.

### Model Order Code.

#### SWH - G02 - C2 - A240

Coil voltage - A110 - 110 VAC  
 - A240 - 240 VAC  
 - D12 - 12 VDC  
 - D24 - 24 VDC

Spool type (see page D10)  
 Interface 02 : NFPA D03 / ISO 4401-03 / CETOP 3/NG 06  
 Subplate mounted  
 High press, high flow solenoid valve

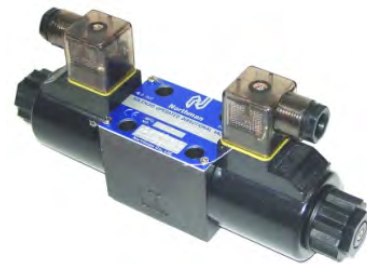

Model	Description	Max. Flow <i>lpm</i>	Max. Pressure <i>bar</i>
SWH-G02-B* - ***	Single solenoid, 2 position	63	310
SWH-G02-C*B - ***	Single solenoid, 2 position	63	310
SWH-G02-C* - ***	Double solenoid, 3 position	63	310

\* - Spool number  
 \*\*\* - Solenoid voltage











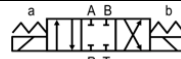
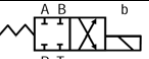
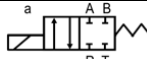
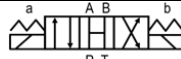
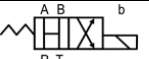
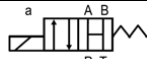
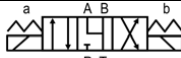
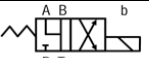
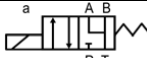
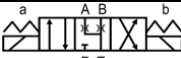
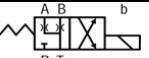
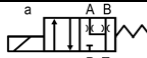

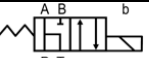

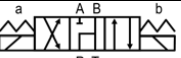
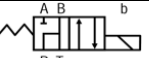
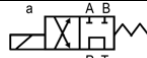
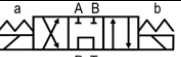
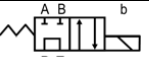
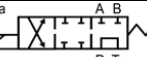
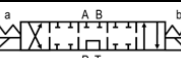
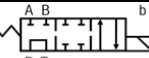
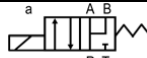

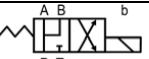

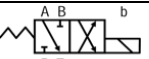
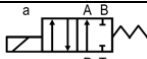

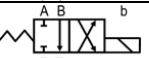
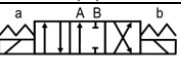
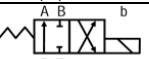
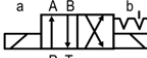
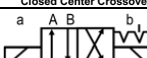
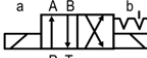
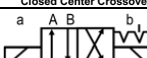
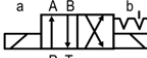
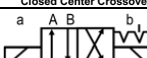
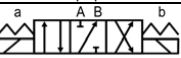
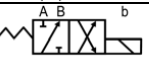
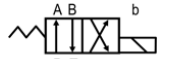
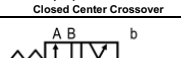
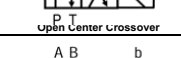
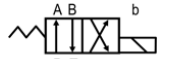
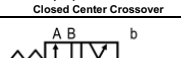
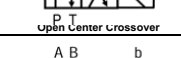

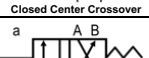
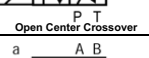
Model	Description
HS31SS	Steel Sub-plate, 3/8" BSP, side ported

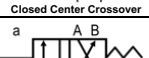
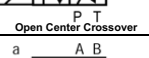
Spare Components	
NWH-02-A110	110VAC/60Hz coil
NWH-02-A240	240VAC/60Hz coil
NWH-02-D12	12VDC coil
NWH-02-D24	24VDC coil
SWH-DC-20-DIN	Hirschmann Plug DC
SWH-AC-20-DIN	Hirschmann Plug AC
ISOL-30REC	DIN rectifier plug with LED – 24V AC to DC

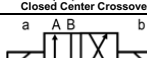
## Solenoid Valves & Accessories - Northman

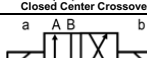
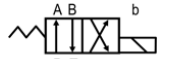
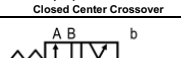
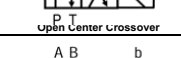
### Cetop Spool And Solenoid Configurations

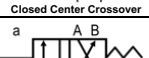
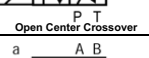
To specify the correct valve for your application, select from the following chart or consult with your Hydraulic Specialties engineer.

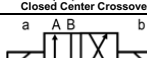
4-WAY, 3-POSITION SPRING CENTERED		4-WAY, 2-POSITION SPRING OFFSET END-TO-CENTER, RIGHT HAND		4-WAY, 2-POSITION SPRING OFFSET END-TO-CENTER, LEFT HAND																							
C2		C2B		C2BS																							
C3		C3B		C3BS																							
C4		C4B		C4BS																							
C40		C40B		C40BS																							
C5		C5B		C5BS																							
C5S		C5SB		C6BS																							
C6		C6B		C60BS																							
C60		C60B		C7BS																							
C7		C7B		C8BS																							
C8		C8B		C9BS																							
C8S		C8SB																									
C9		C9B		<table border="1"> <thead> <tr> <th colspan="2">4-WAY, 2-POSITION DETENT, END-TO-END</th> </tr> </thead> <tbody> <tr> <td>D2</td> <td> Closed Center Crossover</td> </tr> <tr> <td>D3</td> <td> Open Center Crossover</td> </tr> </tbody> </table>		4-WAY, 2-POSITION DETENT, END-TO-END		D2	 Closed Center Crossover	D3	 Open Center Crossover																
4-WAY, 2-POSITION DETENT, END-TO-END																											
D2	 Closed Center Crossover																										
D3	 Open Center Crossover																										
C9S		C9SB																									
<table border="1"> <thead> <tr> <th colspan="2">4-WAY, 2-POSITION SPRING OFFSET END-TO-END, RIGHT HAND</th> </tr> </thead> <tbody> <tr> <td>B2</td> <td> Closed Center Crossover</td> </tr> <tr> <td>B3</td> <td> Open Center Crossover</td> </tr> <tr> <td>B20</td> <td> Closed Center Crossover</td> </tr> </tbody> </table>		4-WAY, 2-POSITION SPRING OFFSET END-TO-END, RIGHT HAND		B2	 Closed Center Crossover	B3	 Open Center Crossover	B20	 Closed Center Crossover	<table border="1"> <thead> <tr> <th colspan="2">4-WAY, 2-POSITION SPRING OFFSET END-TO-END, LEFT HAND</th> </tr> </thead> <tbody> <tr> <td>B2S</td> <td> Closed Center Crossover</td> </tr> <tr> <td>B3S</td> <td> Open Center Crossover</td> </tr> <tr> <td>B20S</td> <td> Closed Center Crossover</td> </tr> </tbody> </table>		4-WAY, 2-POSITION SPRING OFFSET END-TO-END, LEFT HAND		B2S	 Closed Center Crossover	B3S	 Open Center Crossover	B20S	 Closed Center Crossover	<table border="1"> <thead> <tr> <th colspan="2">4-WAY, 2-POSITION NO SPRING, NO DETENT</th> </tr> </thead> <tbody> <tr> <td>N2</td> <td> Closed Center Crossover</td> </tr> <tr> <td>N3</td> <td> Open Center Crossover</td> </tr> </tbody> </table>		4-WAY, 2-POSITION NO SPRING, NO DETENT		N2	 Closed Center Crossover	N3	 Open Center Crossover
4-WAY, 2-POSITION SPRING OFFSET END-TO-END, RIGHT HAND																											
B2	 Closed Center Crossover																										
B3	 Open Center Crossover																										
B20	 Closed Center Crossover																										
4-WAY, 2-POSITION SPRING OFFSET END-TO-END, LEFT HAND																											
B2S	 Closed Center Crossover																										
B3S	 Open Center Crossover																										
B20S	 Closed Center Crossover																										
4-WAY, 2-POSITION NO SPRING, NO DETENT																											
N2	 Closed Center Crossover																										
N3	 Open Center Crossover																										

#### Port Interconnection:

- With solenoid "a" energized P→A B→T
- With solenoid "b" energized P→B A→T
- But port interconnections are reversed for C5, C6, and C60 type.

## Solenoid Valves & Accessories - Cetop 3 - Northman



### Cetop 3 Modules

#### Specifications

Max. pressure - 210 bar  
Max. flow capacity - 35 lpm

MRF-02 Series - Relief Valve	
MRF-02P-3-40	Relief on P port to tank
MRF-02A-3-40	Relief on A port to tank
MRF-02B-3-40	Relief on B port to tank
MRF-02C-3-40	A & B port venting to tank
MRF-02D-3-40	A & B port cross over relief

MPR-02 Series - Pressure Reducing Valve	
MPR-02P-3-40	Pressure reducer on P port
MPR-02A-3-40	Pressure reducer on A port
MPR-02B-3-40	Pressure reducer on B port

MT-02 Series - Throttle & Check Valve	
MT-02W-I-40	Throttle & check A & B port, meter in.
MT-02A-I-40	Throttle & check A port, meter in.
MT-02B-I-40	Throttle & check B port, meter in.
MT-02W-40	Throttle & check A & B port, meter out
MT-02A-40	Throttle & check A port, meter out
MT-02B-40	Throttle & check B port, meter out

MPC Series - Pilot Check Valve	
MPC-02W-05-40	Pilot check A & B port
MPC-02A-05-40	Pilot check A port
MPC-02B-05-40	Pilot check B port

MBK Series-Mounting Bolt Kit	
MBK-02-1-1	Valve & one 40mm stack - M5 x 85mm
MBK-02-2-1	Valve & two 40mm stacks - M5 x 125mm
MBK-02-3-1	Valve & three 40mm stacks - M5 x 165mm
MBK-02-4-1	Valve & four 40mm stacks - M5 x 205mm

## Solenoid Valves & Accessories - Cetop 5 - Northman

### SWH-G03 Series Features

- Electrical connections are Hirschman DIN plug in connector. Indicating light plugs are standard.
- Electrical connection points are aligned with the axial direction to be compatible with modular systems.
- For ease of installation and repair, the mounting screws are on the outside of the body.
- Ability to sustain high pressure - 310 bar, allows for large flow rates to 120 lpm.
- The design of the flow passages minimises pressure drop.
- The 4-way, 4 land construction design reduces the flow force and system surging pressure.
- Can sustain back pressure to 160 bar.
- Comes with Hirschmann plug/s and single station bolt kit.

### Specifications

Max. tank pressure - 160 bar  
 Max. freq. of operation - 240 cycles per minute.

### Model Order Code

**SWH - G03 - C2 - A240**

Coil voltage - A110 - 110 VAC  
 - A240 - 240 VAC  
 - D12 - 12 VDC  
 - D24 - 24 VDC

Spool type (see page D10)  
 Interface 03 : NFPA D05 / ISO 4401-05 / CETOP 5/NG 10  
 Subplate mounted  
 High press, high flow solenoid valve



Model	Description	Max. Flow <i>lpm</i>	Max. Pressure <i>bar</i>
SWH-G03-B* <sup>***</sup>	Single solenoid, 2 position	120	310
SWH-G03-C*B <sup>***</sup>	Single solenoid, 2 position	120	310
SWH-G03-C <sup>***</sup>	Double solenoid, 3 position	120	310

\* - Spool number

\*\*\* - Solenoid voltage

Model	Description
HS51SS	Steel Sub-plate, 1/2" BSP, side ported

Spare Components	
NWH-03-A110	110VAC/60HZ coil
NWH-03-A240	240VAC/60HZ coil
NWH-03-D12	12VDC coil
NWH-03-D24	24VDC coil
SWH-DC-20-DIN	Hirschmann Plug DC
SWH-AC-20-DIN	Hirschmann Plug AC
ISOL-30REC	DIN rectifier plug with LED - 24V AC to DC



## Solenoid Valves & Accessories - Cetop 5 - Northman



### Cetop 5 Modules

#### Specifications

Max. pressure	- 210 bar
Max. flow capacity	- 70 lpm

#### MRF-03 Series - Relief Valve

MRF-03P-3-40	Relief on P port to tank
MRF-03A-3-40	Relief on A port to tank
MRF-03B-3-40	Relief on B port to tank
MRF-03C-3-40	A & B port venting to tank
MRF-03D-3-40	A & B port cross over relief

#### MPR-03 Series - Pressure Reducing Valve

MPR-03P-3-40	Pressure reducer on P port
MPR-03A-3-40	Pressure reducer on A port
MPR-03B-3-40	Pressure reducer on B port

#### MT-03 Series - Throttle & Check Valve

MT-03W-I-40	Throttle & check A & B port, meter in.
MT-03A-I-40	Throttle & check A port, meter in.
MT-03B-I-40	Throttle & check B port, meter in.
MT-03W-40	Throttle & check A & B port, meter out
MT-03A-40	Throttle & check A port, meter out
MT-03B-40	Throttle & check B port, meter out

#### MPC Series - Pilot Check Valve

MPC-03W-05-40	Pilot check A & B port
MPC-03A-05-40	Pilot check A port
MPC-03B-05-40	Pilot check B port

#### MBK Series-Mounting Bolt Kit

MBK-03-1-1	Valve & one 55mm stack - M6 x 95mm
MBK-03-2-1	Valve & two 55mm stacks - M6 x 150mm
MBK-03-3-1	Valve & three 55mm stacks - M6 x 205mm
MBK-03-4-1	Valve & four 55mm stacks - M6 x 260mm



## Solenoid Valves & Accessories - Cetop 3 – Eaton/Vickers

### DG4V3 & DG4V3-S Series Features

- Up to 80 l/min at 350 bar.
- International standard interface. The valve mounting face conforms to ISO 4401, size 03 and is compatible with related international standards.
- Moulded coils for maximum insulating properties, which are impervious to dirt and moisture.
- Plug in solenoid for ease of maintenance.

### Model Order Code

**DG4V - 3(S) - 6 - C - MU - G7 - 60**

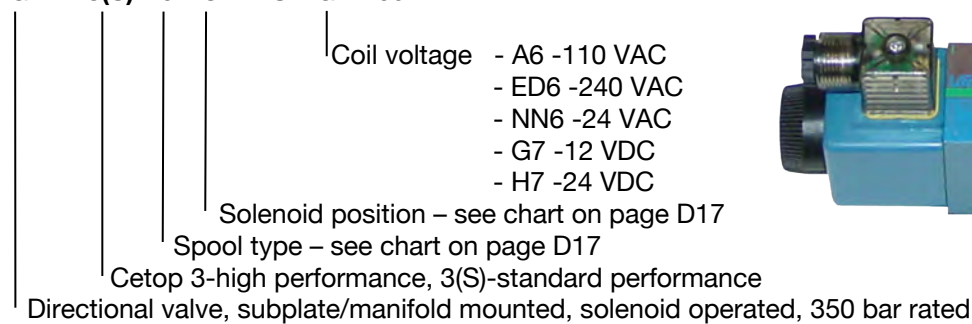

### High Performance Cetop 3

Model	Description	Max. Flow See Chart Below lpm	Max. Press. bar
DG4V-3-*-A**-MU-***-60	Single solenoid, 2 position	60	350
DG4V-3-*-B**-MU-***-60	Single solenoid, 2 position	80	350
DG4V-3-*-C-MU-***-60	Double solenoid, 3 position	80	350
DG4V-3-*-N-MU-H7-60	Double solenoid detent, 2 position	60	350

- \* - Spool type
- \*\* - Solenoid position
- \*\*\* - Coil voltage

- Does not include Hirschmann (DIN) plugs and M5x30 bolt kit
- Maximum tank port pressure is 210 bar - consult Hydraulic Specialties

Max. Flow Rates @ 207 bar Dual Flow Path		
Spool & Position	VAC lpm	VDC lpm
0	60	60
2-C & 2-B	60	80
2-A & 2-N	60	60
6	22	32
8	30	42

Spare Components	
507847	12VDC coil
507848	24VDC coil
507825	110VAC/50HZ coil
507827	240VAC/50HZ coil
865835	24VAC/50HZ coil
HS31SS	Steel Sub-plate, 3/8" BSP, side ported

## Valves & Accessories - Cetop 3 - Eaton/Vickers



### Soft Shifting Cetop 3

Model	Description	Max. Flow <i>See Chart Below</i> lpm	Max. Press. bar
DG4V-3-*-B-207-MU-***-5-60	Single solenoid, 2 position	38	350
DG4V-3-S-2-A-207-MU-***-5-60	Single solenoid, 2 position	15	350
DG4V-3-S-*-C-207-MU-***-5-60	Double solenoid, 3 position	38	350

- \* - Spool type  
\*\*\* - Coil voltage

- Does not include Hirschmann (DIN) plugs and M5x30 bolt kit
- Maximum tank port pressure is 100 bar - consult Hydraulic Specialties
- Response times shown are for a type "2C" spool at a system pressure of 207 bar and a flow of 19 L/min. For different spools and times contact Hydraulic Specialties.

#### Max. Flow Rates @ 207 bar Dual Flow Path

Spool & Position	Flow lpm
0	38
2-C	24
2-A	15
6	17
8	12

#### Spare Components And Accessories

02-123938	12VDC coil
02-123939	24VDC coil
02-140211	Orifice tool kit
635134	0.7mm orifice, one per core tube (Shifts in 625ms, returns in 550ms)
635135	0.8 mm orifice, one per core tube (Shifts in 400ms, returns in 375ms)
893320	0.9 mm orifice, one per core tube (Shifts in 250ms, returns in 250ms)

## Solenoid Valves & Accessories - Cetop 3 – Eaton/Vickers



### Manually Operated Cetop 3

Model	Part Number	Spool And Position	Max. Press. Bar
DG17V3	02-135314	0-C Spring Centred – All ports open	350
DG17V3	02-127343	2-C Spring Centred – All ports closed	350
DG17V3	02-135316	6-C Spring Centred – P blocked, A & B to T	350
DG17V3	02-140909	8-C Spring Centred – P to T, A & B blocked	350

### Hydraulically Operated Cetop 3

Model	Part Number	Spool And Position	Max. Press. Bar
DGV3V	02-154597	2-C Spring Centred – All ports closed	350

- 1/8" BSP pilot and external drain
- Maximum tank port pressure is 207 bar - *consult Hydraulic Specialties*











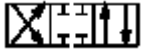

Cetop 3 Spare Components And Accessories	
616452	M5x30 bolt kit
710775	Standard DIN connector plug - Black
710776	Standard DIN connector plug - Grey
ISOL-30R	10-50V AC/DC DIN connector plug with LED
ISOL-80R	70-250V AC/DC DIN connector plug with LED
ISOL-30REC	DIN rectifier plug with LED – 24V AC to DC
HS31SS	Steel Sub-plate, 3/8" BSP, side ported

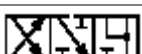
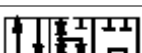
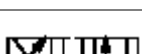
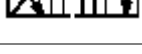
## Solenoid Valves & Accessories - Eaton/Vickers

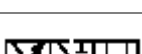
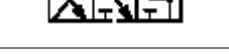

### Cetop Spool & Solenoid Configurations

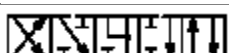
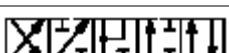
To specify the correct valve for your application, select from the following chart or consult with your Hydraulic Specialties engineer.

Spool Type - Centre Condition	Solenoid Position	Circuit
0 - All ports open	<b>A</b> – Spring offset, end to end, P to A de-energised, P to B energised – single solenoid, 2 position	
2 - All ports blocked	<b>A</b> – Spring offset, end to end, P to A de-energised, P to B energised – single solenoid, 2 position	
0 - All ports open	<b>AL</b> – Spring offset, end to end, P to B de-energised, P to A energised – single solenoid, 2 position	
2 - All ports blocked	<b>AL</b> – Spring offset, end to end, P to B de-energised, P to A energised – single solenoid, 2 position	
0 - All ports open	<b>B</b> – Spring offset, centre to end. Centre position de-energised, P to B energised – single solenoid, 2 position	
2 - All ports blocked	<b>B</b> – Spring offset, centre to end. Centre position de-energised, P to B energised – single solenoid, 2 position	
6 - P blocked, A & B to T	<b>B</b> – Spring offset, centre to end. Centre position de-energised, P to B energised – single solenoid, 2 position	
8 - P to T, A & B blocked	<b>B</b> – Spring offset, centre to end. Centre position de-energised, P to B energised – single solenoid, 2 position	
0 - All ports open	<b>BL</b> – Spring offset, centre to end left hand. Centre position de-energised, P to A energised – single solenoid, 2 position	
2 - All ports blocked	<b>BL</b> – Spring offset, centre to end left hand. Centre position de-energised, P to A energised – single solenoid, 2 position	
6 - P blocked, A & B to T	<b>BL</b> – Spring offset, centre to end left hand. Centre position de-energised, P to A energised – single solenoid, 2 position	
8 - P to T, A & B blocked	<b>BL</b> – Spring offset, centre to end left hand. Centre position de-energised, P to A energised – single solenoid, 2 position	
0 - All ports open	<b>C</b> – Spring centred – double solenoid, 3 position	
2 - All ports blocked	<b>C</b> – Spring centred – double solenoid, 3 position	
6 - P blocked, A & B to T	<b>C</b> – Spring centred – double solenoid, 3 position	
7 - P to A & B, T blocked	<b>C</b> – Spring centred – double solenoid, 3 position	
8 - P to T, A & B blocked	<b>C</b> – Spring centred – double solenoid, 3 position	
33 - P blocked, A & B restricted to T	<b>C</b> – Spring centred – double solenoid, 3 position	
2 - All ports blocked	<b>N</b> – Detented – double solenoid, no springs, 2 position	

## Solenoid Valves & Accessories - Cetop 3 – Eaton/Vickers



### Cetop 3 Systemstak Modules

#### Specifications

Max. pressure - 315 bar  
Max. flow capacity - 60 lpm

DGMC Series - Relief Valve	
694419	Relief on P port to tank, 10-200 bar
869641	Relief on P port to tank, 50-315 bar
869627	A & B port cross over relief, 3-100 bar
871708	A & B port cross over relief, 50-315 bar
871702	A & B port venting to tank, 50-315 bar

DGMX2 - Pressure Reducing/Relieving Valve	
870021	Pressure reducer on P port, 3-30 bar
870036	Pressure reducer on P port, 3.5-70 bar
870037	Pressure reducer on P port, 10-140 bar
870038	Pressure reducer on P port, 20-250 bar

DGMFN - Throttle & Check Valve	
870043	Throttle on P port, meter in.
694413	Throttle & check A & B port, meter in, fine control
694414	Throttle & check A & B port, meter in, standard control
694411	Throttle & check A & B port, meter out, fine control
694412	Throttle & check A & B port, meter out, standard control

DGMPC - Pilot Check Valve	
694400	Dual pilot check A & B port
870024	Pilot check in A port, pilot from B

Mounting Bolt Kits	
464125	Valve & one 40mm stack - M5 x 70mm
466840	Valve & two 40mm stacks - M5 x 110mm
466844	Valve & three 40mm stacks - M5 x 150mm

## Solenoid Valves & Accessories - Cetop 5 – Eaton/Vickers

### DG4V5 Series Features

- Up to 120 lpm and 315 bar.
- International standard interface. The valve mounting face conforms to ISO 4401, size 05 and is compatible with related international standards.
- Moulded coils for maximum insulating properties, which are impervious to dirt and moisture.
- Plug in solenoid for ease of maintenance.
- Indicating signal lights are standard.

### Model Order Code

#### DG4V - 5 - 6 - C - J - MU - G6 - 20

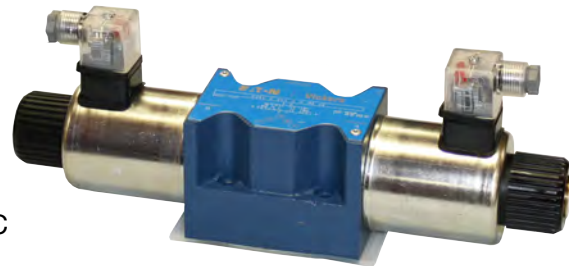
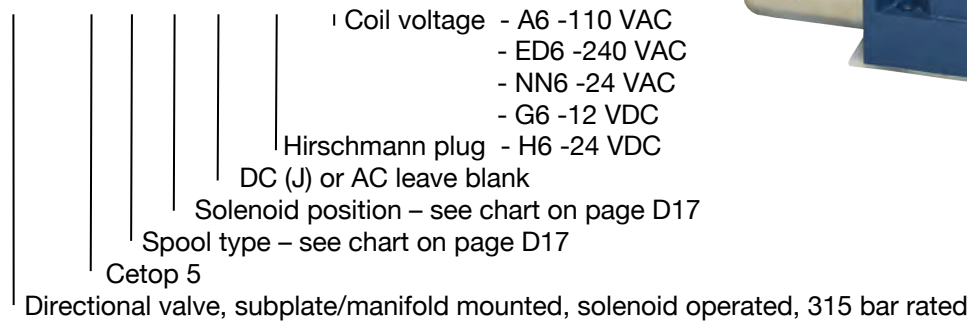

### Standard Cetop 5

Model	Description	Max. Flow <i>See Chart Below</i> lpm	Max. Press. Bar
DG4V-5-* -A** -MU-***-20	Single solenoid, 2 position	105	315
DG4V-5-* -B-MU-***-20	Single solenoid, 2 position	105	315
DG4V-5-* -C-MU-***-20	Double solenoid, 3 position	105	315

- \* - Spool type
- \*\* - Solenoid position
- \*\*\* - Coil voltage

- Does not include Hirschman (DIN) plugs and M6x45 bolt kit
- Maximum tank port pressure is 160 bar for DC and Bar for AC - consult Hydraulic Specialties

Max. Flow Rates @ 207 bar Dual Flow Path		
Spool & Position	VAC lpm	VDC lpm
0-A & 2-A	70	90
0-B & 0-C	85	90
2-B & 2-C	105	105
6	38	42
8	36	62

## Solenoid Valves & Accessories - Cetop 5 – Eaton/Vickers



### Soft Shifting Cetop 5

- Use model code as for standard Cetop 5 but add J99 to end of model code. Requires one per valve, included in the list price.
- DC options only

Model
Single solenoid valves, please specify orifice size
Double solenoid valves, please specify orifice size

Spare Components & Accessories	
617470	12VDC coil
617471	24VDC coil
617475	110VAC/50HZ coil
617477	240VAC/50HZ coil
458502	24VAC/50HZ coil
710775	Standard DIN connector plug - Black
710776	Standard DIN connector plug - Grey
ISOL-30R	10-50V AC/DC DIN connector plug with LED
ISOL-80R	70-250V AC/DC DIN connector plug with LED
HS51SS	Steel Sub-plate, 1/2" BSP, side ported
937571	0.6mm orifice
937572	0.8 mm orifice
937573	1.0 mm orifice
937574	1.2 mm orifice
534569	M6 x 45 bolt kit



## Solenoid Valves & Accessories - Cetop 5 – Eaton/Vickers



### CETOP 5 Systemstak Modules

#### Specifications

Max. pressure - 315 bar  
Max. flow capacity - 120 lpm

DGMC Series - Relief Valve	
867315	Relief on P port to tank, 4-315 bar
867323	A & B port cross over relief, 4-315 bar
02-101918	A & B port venting to tank, 4-200 bar

DGMX2 - Pressure Reducing/Relieving Valve	
868864	Pressure reducer on P port, 8.5-315 bar
868656	Pressure reducer on A port, 8.5-315 bar

DGMFN - Throttle & Check Valve	
867335	Throttle & check A & B port, meter in, standard control
867332	Throttle & check A & B port, meter out, standard control

DGMPC - Pilot Check Valve	
867364	Dual pilot check A & B port

DGMR – Counterbalance Valve	
02-145385	Single, Throttle & check A & B port, meter in, standard control
02-145387	Dual, Throttle & check A & B port, meter out, standard control

Mounting Bolt Kits	
534576	Valve & one 50mm stack - M6 x 90mm
638878	Valve & two 50mm stacks - M6 x 140mm





## Solenoid Valves & Accessories - Cetop 8 – Eaton/Vickers

### DG5S-H8 Series Features

- Up to 530 lpm and 310 bar. Consult Hydraulic Specialties for recommended pressure and flow characteristics.
- International standard interface. The valve mounting face conforms to ISO 4401, size 08 and is compatible with related international standards.
- Moulded coils for maximum insulating properties, which are impervious to dirt and moisture.
- Plug in solenoid for ease of maintenance.
- Indicating signal lights are standard.
- Change of pilot and drain easy to accomplish by plugging or unplugging.
- Spool is designed to avoid creating jet path or turbulence under high pressure and large flow operation.

### Model Order Code

#### DG5S - H8 - 6 - C - E - T - MU - G5 - 50

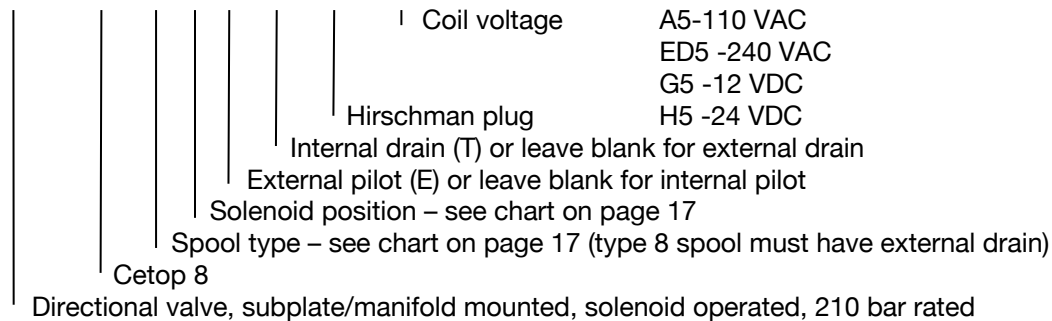

### Cetop 8

Model	Description	Max. Flow <i>lpm</i>	Max. Press. <i>bar</i>
DG5S-H8-2-A-MU-***-50	Single solenoid, 2 position	530	310
DG5S-H8-*C-MU-***-50	Double solenoid, 3 position	530	310

\* - Spool type

\*\* - Solenoid position

\*\*\* - Coil voltage

- Does not include Hirschman (DIN) plugs and sub-plate bolt kit
- Maximum tank port pressure is 310 bar for external drain, and 210 bar for internal drain - consult Hydraulic Specialties
- A back-pressure check valve for the internal pilot version is needed on the tank port - consult Hydraulic Specialties
- A full range of high and low-pressure sub-plates are available in single or multiple station - consult Hydraulic Specialties

### Spare Components & Accessories

788246	Sub-plate, 1 1/4" BSP, rear ported
791551	Cetop 8 bolt kit
694411	Pilot choke kit
464125	70mm bolt kit for pilot choke
710775	Standard DIN connector plug - Black
710776	Standard DIN connector plug - Grey
ISOL-30R	10-50V AC/DC DIN connector plug with LED
ISOL-80R	70-250V AC/DC DIN connector plug with LED
ISOL-30REC	DIN rectifier plug with LED – 24V AC to DC

## Solenoid Valves & Accessories - Cetop 3 – Bosch Rexroth

### WE Series, Size 6 (Cetop 3)

- Up to 80 l/min at 350 bar.
- International standard interface. The valve mounting face conforms to ISO 4401.
- Moulded coils for maximum insulating properties, which are impervious to dirt and moisture.
- Plug in solenoid for ease of maintenance.
- 4/3-, 4/2- or 3/2-way version
- High-power solenoid, optionally rotatable by 90°
- Electrical connection as individual or central connection
- Manual override, optional
- Spool position monitoring, optional



## Solenoid Valves & Accessories - Cetop 5 – Bosch Rexroth

### WE Series, Size 10 (Cetop 5)

- Up to 120 l/min at 315 bar.
- International standard interface. The valve mounting face conforms to ISO 4401.
- Moulded coils for maximum insulating properties, which are impervious to dirt and moisture.
- Plug in solenoid for ease of maintenance.
- 4/3-, 4/2- or 3/2-way version
- High-power solenoid, optionally rotatable by 90°
- Electrical connection as individual or central connection
- Manual override, optional
- Spool position monitoring, optional



**Contact Hyspecs to specify the correct Cetop valve for your application.**

## Proportional Valves - Eaton/Vickers Cetop

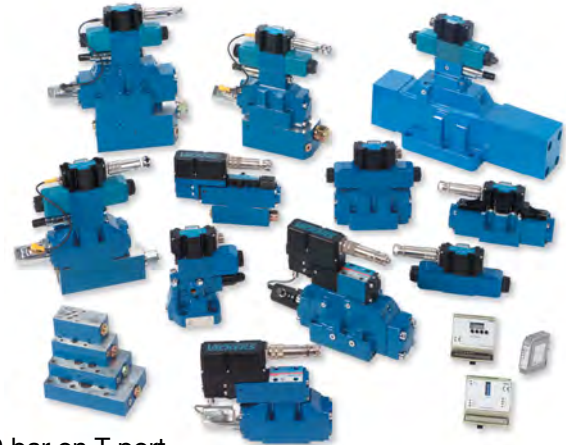

### Directional Valve – KDG4V3-S

- Maximum pressure on P, A & B ports is 350 bar and 210 bar on T port

Part Number	Spool & Position	Metering	Max. Flow lpm	Voltage VDC
02-135150	33-C	Meter in only	8	24
02-140085	33-C	Meter in only	22	24
02-135162	2-C	Meter in/Meter out	8	24
02-149542	2-C	Meter in/Meter out	19	24

- Valves are available with feedback, on board electronics. Also available in Cetop 5 - consult Hydraulic Specialties

### Relief Valves – KCG3

Part Number	Description	Pressure Range bar	Max. Flow lpm	Voltage VDC
02-145957	Single solenoid, B end	4-160	5	24
02-145955	Single solenoid, B end	5-250	5	12
02-145959	Single solenoid, B end	6-350	5	24
02-146068	Single solenoid, A end	6-350	5	24

- Use bolt kit 255699, M5x50mm
- Size 6 (200 lpm) and size 8 (400 lpm) proportional relief valves are also available - consult Hydraulic Specialties
- Size 6 (200 lpm) and size 8 (300 lpm) proportional pressure reducers are also available - consult Hydraulic Specialties

### Throttle Valve – KTG4V3-S

- Maximum pressure on P, A & B ports is 350 bar and 210 bar on T port

Part Number	Spool & Position	Metering	Max. Flow lpm	Voltage VDC
02-148871	2-B	Meter in/Meter out	8	24
02-155321	2-B	Meter in/Meter out	15	24

Valves are available with feedback, on board electronics. Also available in Cetop 5 - consult Hydraulic Specialties

## Proportional Cetop Valves - Eaton/Vickers Cetop

### Proportional Cetop Valve Accessories

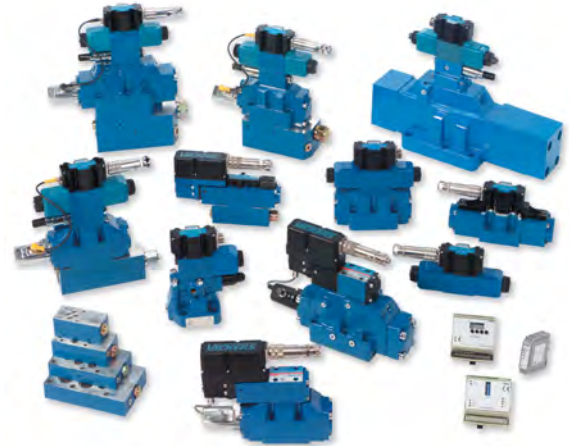

### Amplifier Plugs

Part Number	Function	Valves used with	Ramp Times	Max. Output Current A	Command Signal	Power Supply VDC
02-326009	Soft Shift	CMX, EPV,	50ms – 5s	1.6	24 VDC	24
02-326010	Proportional	KCG, KDG,	50ms – 5s	1.6	0-10 V	24
02-326012	Proportional	KTG, KXCG,	50ms – 5s	1.6	4-20 mA	24
02-326013	Proportional	ERV, EPRV	50ms – 5s	3.0	0-10 V	12

### Mobile Soft Shift Amplifier

Part Number	Function	Valves used with	Ramp Times	Max. Output Current A	Command Signal	Power Supply VDC
02-104848	Soft Shift Dual Coils	CMX, EPV, KCG, KDG, KTG, KXCG, ERV, EPRV	50ms – 5s	0.8	24 VDC	24

### Amplifier Cards

Part Number	Function	Valves used with	Ramp Times	Max. Output Current A	Command Signal	Power Supply VDC
02-326020	Proportional	KCG	20ms – 2s	1.8	0-10 V or 0-20mA	24
02-326001	Proportional	KTG4V3(S) / KDG4V3(S)	50ms – 5s	1.6	-10 to 10 V or -20 to 20mA	24
02-326024	Proportional	KFD/TG4V-5	50ms – 5s	1.6	-10 to 10 V or -20 to 20mA	24

### Spare Components & Accessories

E01222	Hirschman plug base
02-104808	Card holder

- Note that other amplifiers are available on request – Contact Hydraulic Specialties

## Load Sensing Valves – DLS7 Walvoil

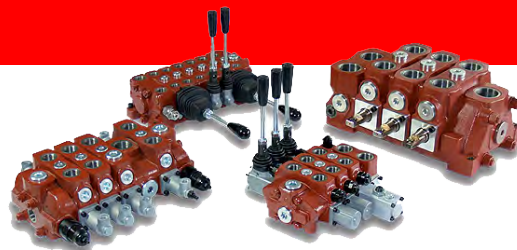

- The DLS7 is a sectional valve designed for systems with fixed displacement pumps (open centre version), or variable displacement pumps (closed centre version).
- Load independant flow control.
- Load sense signal connections on every working section.
- Nominal flow rating (with 14 bar standby) on inlet port P, 75 l/min and on ports A and B, 60 l/min.
- Operating pressure (max.) 315 bar.
- Back pressure (max.) on outlet port T, 25 bar.
- Can stack valves up to 12 sections. Tie rod kits up to 8 sections in stock.
- **Compensated on the inlet only.**

To configure a valve use the below valve components and options starting with an inlet option, add the number of required work sections and tie rod kit. Then select your lever box options, any relief/anticav protection required and end cover. Contact Hyspecs for more options.

### Valve Components and Options

Part Number	Description
61B331000	Inlet open centre with relief (Type AM)
61B332000	Inlet closed centre with LS relief (Type AN)
61B333000	Inlet closed centre without relief (Type AP)
61B13****	Work section complete with spool 10-60 l/min
5TIR108126	Tie rod kit for 1 section
5TIR108166	Tie rod kit for 2 sections
5TIR108204	Tie rod kit for 3 sections
5TIR108242	Tie rod kit for 4 sections
5TIR108280	Tie rod kit for 5 sections
5TIR108318	Tie rod kit for 6 sections
5TIR108356	Tie rod kit for 7 sections
5TIR108432	Tie rod kit for 8 sections
5LEV107800	Lever box with stroke limiters
5V08205000	Spring centre kit
5V07405000	Friction detent kit
5V11105000	3 position detent kit
5KIT4061**	Anti cavitation valve
5KIT206***	Port relief (option of 20-80 bar, 50-220 bar, 180-350 bar)
5KIT306***	Port relief with anti-cav (option of 20-80 bar, 50-220 bar, 180-350 bar)
XTAP524280	Cavity plug
61B431000	End cover
3CU31****	Spare / replacement spool, 10-60 l/min

- Anything with a \* in the model number indicates there are options for that choice - **contact Hyspecs.**
- Options are available for pneumatic, hydraulic and cable control of the spools - **contact Hyspecs.**



## Proportional Sectional Valves – DPC130 Walvoil

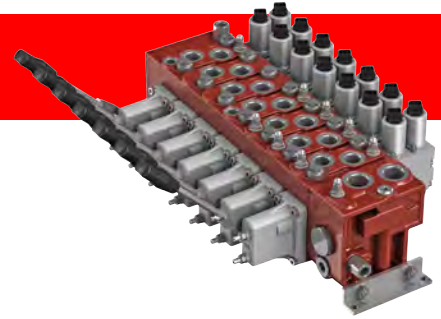

- Nominal flow rating 150 l/min. Max operating pressure 315 bar. Max back pressure on T 25bar. Max pressure on drain L 2.5bar. Fluid temperature -20 to 80 deg C. Ambient temperature - 20 to 60 deg C.
- These stackable valves are used for systems with constant displacement pumps (open centre version) or variable displacement pumps (closed centre version).
- Load independent flow control.
- Internal pilot oil supply built into inlet cover.
- Options for electrical LS unloading valves.
- Interchangeable spools.
- A wide variety of service ports valves.
- Available manual, hydraulic and electro—hydraulic proportional spool control kits.
- Available with compensated or non compensated working sections.
- Safety and diagnostics available on the 8ZR proportional electro—hydraulic control spool kit closed loop system, with electronic on-board.
- Up to 10 sections

### Select Inlet

INLET TYPE		code	part number	notes
open centre fixed displacement pumps	with press reducing VR	BR11	5FIA630301	use for electro-hydraulic working sections
	without press reducing	BN11	5FIA630303	use for manual & hydraulic remote working sections
closed centre variable displacement pumps	with press reducing VR	BR21	5FIA630300	use for electro-hydraulic working sections
	with press reducing VR & without compensator C3	BRF21	5FIA630306	use for electro-hydraulic sections
	without press reducing	BN21	5FIA630302	use for manual & hydraulic remote working sections
closed centre with LS dampening	with press reducing	BRS21	5FIA630360	use where load oscillations can occur

# Proportional Sectional Valves – DPC130 Walvoil



## Inlet Options

INLET OPTIONS		code	part number	notes
inlet relief BR & BN inlets	40-180 bar	S	XCAR126215	used in open & closed center inlet
	180-350 bar	S	XCAR126213	used in open & closed center inlet
	cavity plug	ST	5KIT126210	used in closed centre inlet only
LS unload BR inlet only	solenoid valve 12VDC	ELN	5CAR426310	
	solenoid valve 24VDC	ELN	5CAR426315	
	cavity plug	LT	XTAP222340	

Code	Part Number	Description
BR11	5FIA630301	Use for electro-hydraulic working sections
BN11	5FIA630303	Use for manual & hydraulic remote working sections
BR21	5FIA630300	Use for electro-hydraulic working sections
BRF21	5F1A630306	Use for Electro-hydraulic working sections
BN21	5FIA630302	Use for manual & hydraulic remote working sections
BRS21	5FIA630360	Use where load oscillations can occur
S	XCAR126215	Relief 40-180 bar, used in open & closed centre inlet
S	XCAR126213	Relief 180-350 bar, used in open & closed centre inlet
ST	5KIT126210	Cavity plug, used in closed centre inlet only
ELN	5CAR426310	Load sense unloading solenoid valve 12VDC
ELN	5CAR426315	Load sense unloading solenoid valve 24VDC
LT	XTAP225320 (replaces XTAP222340)	Cavity plug
	5KIT130300	Converts inlet from open centre to closed centre
	5KIT130310	Converts inlet from closed centre to open centre



# Proportional Sectional Valves – DPC130 Walvoil

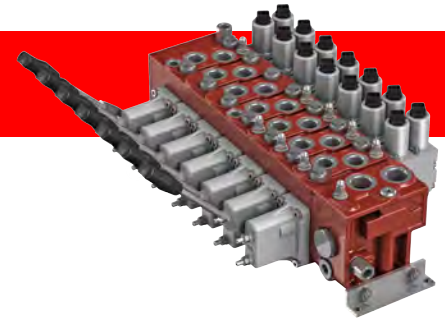

## Select Working Section

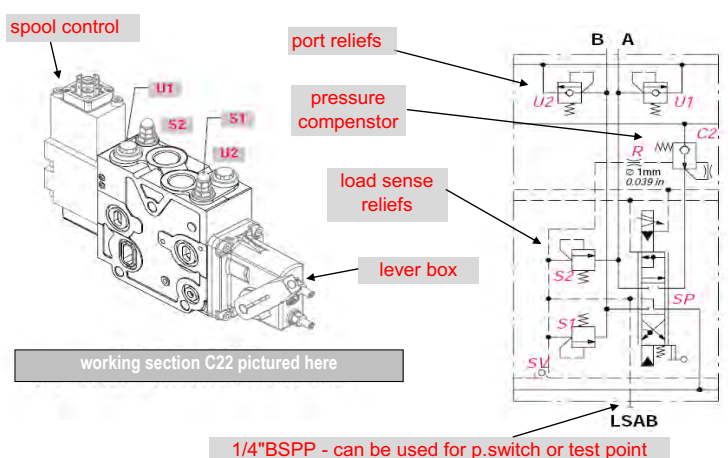
WORKING SECTION TYPE		code	part number	notes
working section body	compensated with port relief cavities U1 & U2	C20	5EL6301320	 <p>1/4"BSPP - can be used for p.switch or test point</p>
	compensated with PR and LS cavities U1,U2,S1 & S2	C22	5EL6301322	
	non-compensated with port relief cavities U1 & U2	D10	5EL6302320	

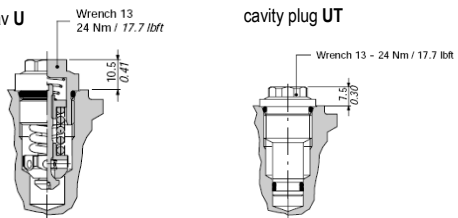
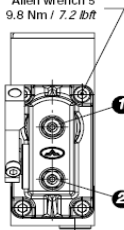
W/S OPTIONS		code	part number	notes
port relief + anti-cavitation	50 bar	U050	5KIT330050	 <p>2 per working section required.</p>
	100 bar	U100	5KIT330100	
	150 bar	U150	5KIT330150	
	200 bar	U200	5KIT330200	
	250 bar	U250	5KIT330250	
	300 bar	U300	5KIT330300	
	cavity plug	UT	XTAP522441	
LS reliefs	40-180 bar	S	XCAR126215	For C22 section only. 2 per working section required.
	180-350 bar	S	XCAR126213	
spool control	spring return	8	5V08130000	
	proportional 12V solenoid	8EZ3	5V08130780	can be used as ON/OFF solenoid or proportional via suitable valve driver. See next page for electrical connection information.
	proportional 24V solenoid	8EZ3	5V08130781	can be used as ON/OFF solenoid or proportional via suitable valve driver. See next page for electrical connection information.
	proportional E/H + OBE	8ZR3	5V08130900	PC programmable - accepts inputs from joysticks, pots, PLC etc. See next page for electrical connection information.
	hydraulic proportional	8IM	5V08130800	range 5-15 bar (73 to 220 psi). See next page for pilot pressure graph.
	friction detent	7FT	5V07130000	min 20N, max 150N, standard 100N (adjustable)
lever box	lever box with stroke limiters	L	5LEV130712	 <p>1 per working section required</p> <ol style="list-style-type: none"> <li>Stroke end screw for position A (P=A): allen wrench 3 Fixing nut: wrench 10 – 9.8 Nm / 7.2 lbf</li> <li>Stroke end screw for position B (P=B): allen wrench 3 Fixing nut: wrench 10 – 9.8 Nm / 7.2 lbf</li> </ol>
	handle M8x170MM	HDL	170011117	

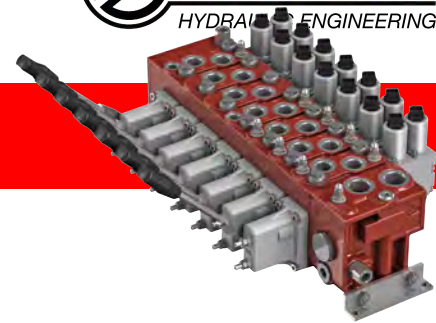

## Proportional Sectional Valves – DPC130 Walvoil

### Select Working Section (Continued)

W/S OPTIONS		code	part number	notes
spool options	doble acting motor 25l/min	2V	3CU4024025	
	doble acting motor 60l/min	2S	3CU4024060	
	doble acting motor 100l/min	2P	3CU4024100	
	doble acting cylinder 25l/min	1V	3CU4010025	
	doble acting cylinder 60l/min	1S	3CU4010060	
	doble acting cylinder 100l/min	1P	3CU4010100	
	single acting on A, B plugged 100l/min	3P	3CU4031080	

Code	Part Number	Description
C20	5EL6301320	Compensated with port relief cavities U1 & U2
C22	5EL6301322	Compensated with PR and LS cavities U1,U2,S1 & S2
D10	5EL6302320	Non-compensated with port relief cavities U1 & U2
U050	5KIT330050	50 bar port relief + anti-cavitation
U100	5KIT330100	100 bar port relief + anti-cavitation
U150	5KIT330150	150 bar port relief + anti-cavitation
U200	5KIT330200	200 bar port relief + anti-cavitation
U250	5KIT330250	250 bar port relief + anti-cavitation
U300	5KIT330300	300 bar port relief + anti-cavitation
UT	XTAP522441	Cavity plug
S	XCAR126215	40-180 bar load sense relief
S	XCAR126213	180-350 bar load sense relief
8	5V08130000	Spool control - spring return
8EZ3	5V08130780	Spool control - proportional 12V solenoid ISO4400
8EZ3	5V08130781	Spool control - proportional 24V solenoid ISO4400
8EZ34	5V08130872	Spool control – proportional 12V solenoid Deutsch
8EZ4	5V08130873	Spool control – proportional 24V solenoid Deutsch
8ZR3	5V08130900	Spool control - proportional E/H + OBE
8IM	5V08130800	Spool control - hydraulic proportional
7FT	5V07130000	Spool control - friction detent
L	5LEV130712	Lever box with stroke limiters
HDL	170011117	Handle M8x170MM
2V	3CU4024025	Spool - double acting motor 25l/min
2S	3CU4024060	Spool - double acting motor 60l/min
2P	3CU4024100	Spool - double acting motor 100l/min
1V	3CU4010025	Spool - double acting cylinder 25l/min
1S	3CU4010060	Spool - double acting cylinder 60l/min
1P	3CU4010100	Spool - double acting cylinder 100l/min
3P	3CU4031080	Spool - single acting on A, B plugged 100l/min

# Proportional Sectional Valves – DPC130 Walvoil

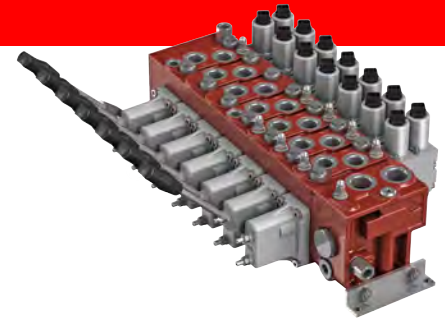

## Select Outlet

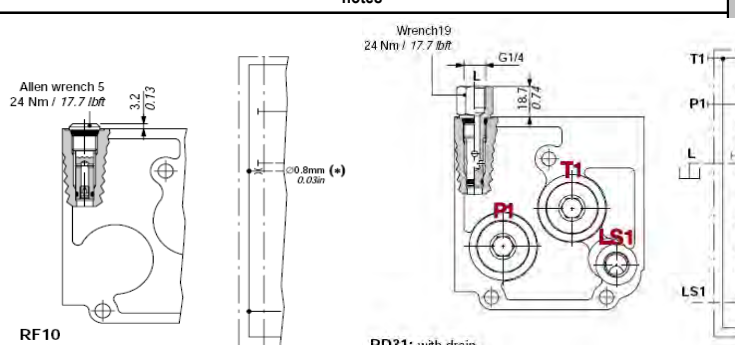
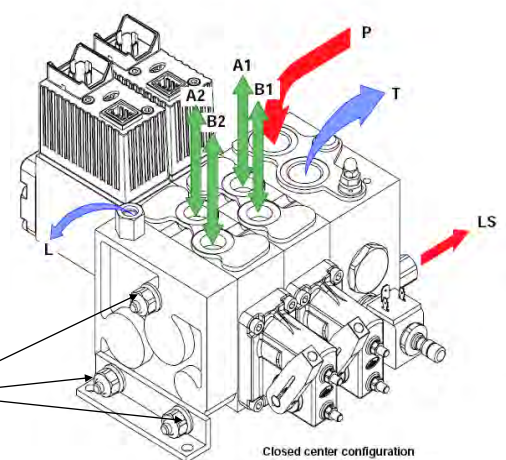
OUTLET TYPE TYPE		code	part number	notes
OUTLET	without ports	RF	3FIA731000	On RD cover P, T = 3/4" BSPP, LS = 1/4" BSPP.
	with P,T and LS ports	RD	3FIA731320	
DRAIN OPTIONS		code	part number	notes
DRAIN	plug for manual control (7FT/8)	1	XTAP517460	
	plug for hydraulic prop (8IM) control	2	XTAP217160	
	sleeve for electro-hydraulic control (8EZ3/8ZR3)	3	XCAR119611	
TIE ROD KITS		no of sections	part number	notes
TIE RODS	DPC130/1	1	5TIR108185	
	DPC130/2	2	5TIR108232	
	DPC130/3	3	5TIR108281	
	DPC130/4	4	5TIR108328	
	DPC130/5	5	5TIR108376	
	DPC130/6	6	5TIR108425	
	DPC130/7	7	5TIR108472	
	DPC130/8	8	5TIR108520	

Code	Part Number	Description
RF	3FIA731000	Outlet without ports
RD	3FIA731320	Outlet with P,T and LS ports
1	XTAP517460	Drain plug for manual control (7FT/8)
2	XTAP217160	Drain plug for hydraulic prop (8IM) control
3	XCAR119611	Drain sleeve for electro-hydraulic control (8EZ3/8ZR3)

# Proportional Sectional Valves – DPC130 Walvoil

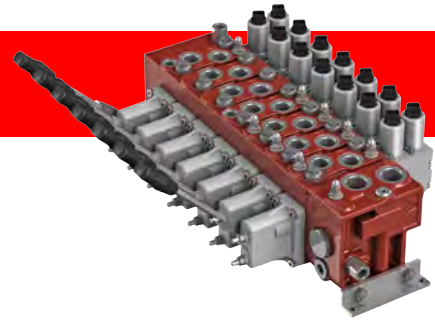

## Select Outlet (Continued)

Code	Part Number	Description
1	5TIR108185	Tie Rods, DPC130/1 – one section
2	5TIR108232	Tie Rods, DPC130/2 – two sections
3	5TIR108281	Tie Rods, DPC130/3 – three sections
4	5TIR108328	Tie Rods, DPC130/4 – four sections
5	5TIR108376	Tie Rods, DPC130/5 – five sections
6	5TIR108425	Tie Rods, DPC130/6 – six sections
7	5TIR108472	Tie Rods, DPC130/7 – seven sections
8	5TIR108520	Tie Rods, DPC130/8 – eight sections

SPOOL CONTROL INFORMATION		
<p><b>PROPORTIONAL WITH OBE - 8ZR3</b></p> <p><b>Main connector</b></p> <ol style="list-style-type: none"> <li>1 Power supply (+)</li> <li>2 Set point</li> <li>3 Alarm output</li> <li>4 Power supply (-)</li> </ol> <p>Connection ISO4400 (needs connector type C03, see page 93)</p> <p>4 pin hirshmann connector plug Part #: 2X1001030</p>	<p><b>PROPORTIONAL COIL - 8EZ3</b></p> <p><b>Connector</b></p> <ol style="list-style-type: none"> <li>1 Power supply (-)</li> <li>2 Port B</li> <li>3 Port A</li> <li>4 (Gnd) Ground</li> </ol> <p>Connection ISO4400 (needs connector type C02, see page 93)</p> <p>4 pin hirshmann connector plug Part #: 2X1001030</p>	<p><b>HYDRAULIC REMOTE - 8IM</b></p> <p>Pressure-stroke diagram</p> <p>Port B ← 0 → Port A</p> <p>Stroke (mm)</p> <p>Pilot pressure (bar)</p> <p>Legend:   Spool overlap area   Metering area</p>
<p>4001417</p>	<p>Deutsch DT06-25 Connector Plug 4001417</p>	

## Proportional Sectional Valves – DPC200 Walvoil



- Nominal flow rating 260 l/min. Max operating pressure 350 bar. Max back pressure on T, 25bar. Max pressure on drain L, 2.5bar. Fluid temperature -20 to 80 deg C. Ambient temperature - 20 to 60 deg C.
- These stackable valves are used for systems with constant displacement pumps (open centre version) or variable displacement pumps (closed centre version).
- Load independent flow control.
- Internal pilot oil supply built into inlet cover.
- Options for electrical LS unloading valves.
- Interchangeable spools.
- A wide variety of service ports valves.
- Available manual, hydraulic and electro—hydraulic proportional spool control kits.
- Available with compensated or non-compensated working sections.
- Electro-hydraulic kits are available with analogue or digital spool position sensors.
- Can stack valves up to 10 sections. Tie rod kits up to 8 sections in stock.
- DPC130 and DPC200 valves can be joined together with an adaptor interface.

To configure a valve use the below valve components and options starting with an inlet option, add the number of required work sections, spools and tie rod kit. Then select your lever box options, any relief/anticav protection required and end cover. Contact Hyspecs for more options.

### Valve Components and Options

Part Number	Description
5FIA620302	Inlet open centre with PRV BR11
5FIA620304	Inlet closed centre with PRV BR21
5EL6201322	Working section without spool
3CU45****	Spool (option of DA/SA/Motor/Cylinder, 50, 100, 150, 200 l/min)
5TIR112***	Tie Rod Kit 1-8 sections stocked
5LEV200701	Lever box with stroke limiter
5V07200000	Friction detent kit
5V08200000	Spring return kit
5V08200722	Electro hydraulic kit 12VDC deutsch connector
5V08200742	Electro hydraulic kit 24VDC deutsch connector
5V08200801	Proportional hydraulic control kit, 5.2 – 15.3 bar
4AC9539900	Pressure reducing valve
5KIT409000	Anti-cavitation valve
5KIT340****	Port relief with anti-cav (option of 50, 100, 250, 350 bar)
XTAP324541	Pressure reducing cavity plug
XTAP528520	Relief blanking plug
5FIA720300	End cover without ports
5FIA720302	End cover with P, T and LS ports
638403001	DPC130-200 joiner kit

- Anything with a \* in the model number indicates there are options for that choice - **contact Hyspecs.**
- Options are available for pneumatic, hydraulic and cable control of the spools - **contact Hyspecs.**



## Proportional Sectional Valves – PVG32 Danfoss

PVG load-sensing proportional valves features and benefits:

- Load-independent flow control:
  - - Oil flow to an individual function is independent of the load pressure of this function
  - - Oil flow to one function is independent of the load pressure of other functions
- Possible combination with the rest of the PVG family, when using an interface module
- Up to 12 basic modules per PVG 32 valve group
- Reliable regulation characteristics across the entire flow range
- Load sense relief valves for A and B port enables reduced energy loss at target pressure
- Several options for connection threads and flange mount
- Compact design, easy installation and serviceability
- **Our commonly stocked range is the PVHC actuated PVG32. There are many other options available. Contact your Hyspecs rep for full valve specification & pricing.**



<b>Maximum pressure</b>	<b>Port P, A/B continuous with PVS end plate</b>	300 bar	[4351 psi]
	<b>Port P, A/B continuous with PVS1 end plate</b>	350 bar	[5075 psi]
	<b>Port P intermittent</b>	400 bar	[5800 psi]
	<b>Port A/B intermittent</b>	420 bar	[6090 psi]
	<b>Port T, static/dynamic</b>	25/40 bar	[365/580 psi]
<b>Oil flow rated</b>	<b>Port P with PVP inlet</b>	140 l/min	[37 US gal/min]
	<b>Port P with PVP/PVPVM mid inlet</b>	230 l/min	[61 US gal/min]
	<b>Port A/B with pressure compensator</b>	100 l/min	[26.4 US gal/min]
	<b>Port A/B without pressure compensator</b>	125 l/min	[33 US gal/min]
<b>Spool travel, standard</b>		± 7 mm	[± 0.28 in]
<b>Spool travel, float position</b>	<b>Proportional range</b>	± 4.8 mm	[± 0.19 in]
	<b>Float position</b>	± 8 mm	[± 0.32 in]
<b>Dead band, flow control spools</b>	<b>Standard</b>	± 1.5 mm	[± 0.06 in]
	<b>Linear characteristic</b>	± 0.8 mm	[± 0.03 in]
<b>Maximum internal leakage at 100 bar [1450 psi] and 21 mm<sup>2</sup>/s [102 SUS]</b>	<b>A/B → T, PVB without PVLP</b>	20 cm <sup>3</sup> /min	[1.85 in <sup>3</sup> /min]
	<b>A/B → T, PVB with PVLP</b>	25 cm <sup>3</sup> /min	[2.15 in <sup>3</sup> /min]
<b>Maximum internal leakage at 200 bar [2900 psi] and 21 mm<sup>2</sup>/s [102 SUS]</b>	<b>A/B → T, PVBZ with PO check valves</b>	1 cm <sup>3</sup> /min	[0.06 in <sup>3</sup> /min]
	<b>A/B → T, PVBZ with PO check valves and PVLP</b>	6 cm <sup>3</sup> /min	[0.37 in <sup>3</sup> /min]
<b>Oil temperature (inlet temperature)</b>	<b>Recommended temperature</b>	30 to 60 °C	[86 to 140 °F]
	<b>Minimum temperature</b>	-30 °C	[-22 °F]
	<b>Maximum temperature</b>	90 °C	[194 °F]
<b>Ambient temperature</b>		-30 to 60 °C	[-22 to 140 °F]
<b>Oil viscosity</b>	<b>Operating range</b>	12 to 75 mm <sup>2</sup> /s	[65 to 347 SUS]
	<b>Minimum viscosity</b>	4 mm <sup>2</sup> /s	[39 SUS]
	<b>Maximum viscosity</b>	460 mm <sup>2</sup> /s	[2128 SUS]
<b>Filtration / maximum contamination according to ISO 4406</b>		23/19/16	
<b>Oil consumption in pilot oil reduction valve</b>		0.5 l/min	[0.13 US gal/min]

## Proportional Sectional Valves – PVG32 Danfoss

### Select Inlet

The **Open Centre PVP inlet** with integrated pilot pressure reduction valve (PPRV) is intended for use with fixed displacement pumps in applications, where a valve group with electro-hydraulically or hydraulically controlled work sections is desired (PVE or PVH/PVHC).



- Integrated LS pressure relief valve
- Threaded ports for P/T/LS and M measuring gauge
- Integrated pilot pressure reducing valve (PPRV) for PVE or PVH/PVHC
- Optional T0 facility and external T0 port
- Optional external pilot pressure port (Pp)
- Optional LS unloading valve, PVPX
- Models with T0 port have internal T0 connection closed by default.
- All modules can be manually activated with the PVM actuation.

*Open center PVP with PPRV schematic*

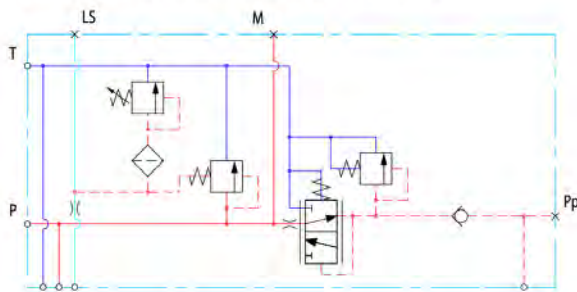

*Open center PVP with PPRV and T0*

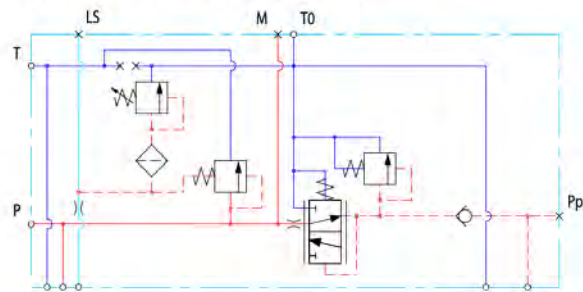

The **Closed Centre PVP inlet** with integrated pilot pressure reduction valve (PPRV) is intended for use with variable displacement pumps in applications where a valve group with electro-hydraulic or hydraulically controlled work sections is desired.

- Integrated LS pressure relief valve
- Threaded ports for P/T/LS and M measuring gauge
- Integrated pilot pressure reducing valve (PPRV) for PVE or PVH/PVHC
- Optional T0 facility and external T0 port
- Optional LS unloading valve, PVPX
- Models with T0 port have internal T0 connection closed by default.

*Closed center PVP with PPRV schematic*

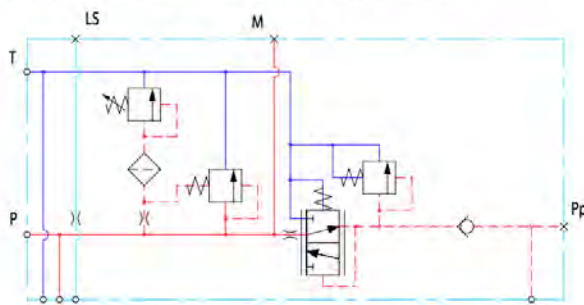

*Closed center PVP with PPRV and T0*

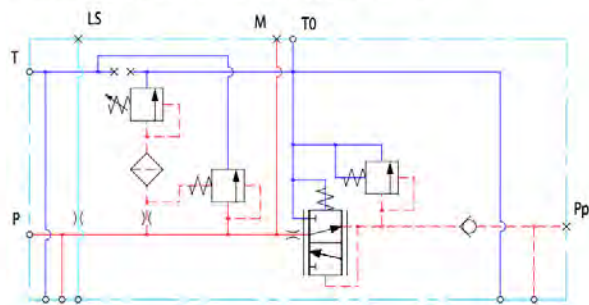

## Proportional Sectional Valves – PVG32 Danfoss

### Select Inlet

- P and T-ports G3/4", LS Port G1/4" and mounting holes M8



Code	Description
157B5190	Danfoss PVP inlet module open centre c/w pilot supply for PVH/PVHC
157B5191	Danfoss PVP inlet module closed centre c/w pilot supply for PVH/PVHC

### Select Inlet Module Accessories

#### PVPX Electrical LS Pressure Unloading Valve

The electrical LS pressure unloading valve is an accessory available for PVP inlet modules with PVPX facility. The PVPX consist of a solenoid valve and a magnetic coil package, allowing the operator to relieve the LS pressure to tank electrically.

#### PVPC without Check Valve

The PVPC external pilot pressure adapter without check valve is an accessory in the M-port available for PVP inlet modules with integrated pilot pressure reduction valve (PPRV). The PVPC without check valve cuts off the integrated PPRV to the PVE or PVH/PVHC in the valve group and enables an external pilot pressure supply through the PVPC adapter.

#### PVPC with Check Valve

The PVPC external pilot pressure adapter with check valve is an accessory in the M-port available for PVP inlet modules with integrated pilot pressure reduction valve (PPRV). The PVPC with check valve enables an external pilot pressure supply through the PVPC adapter and the PPRV, while also allowing the main pump to supply the PPRV through the P-gallery as a standard Open Centre PVP with PPRV.

Code	Description
11180766	Danfoss PVPX electrical LS unloader 12VDC deutsch normally open
11180767	Danfoss PVPX electrical LS unloader 24VDC deutsch normally open
11180768	Danfoss PVPX electrical LS unloader 12VDC deutsch normally closed
11180769	Danfoss PVPX electrical LS unloader 24VDC deutsch normally closed
157B5400	Danfoss PVPC external pilot pressure adaptor without check
157B5600	Danfoss PVPC external pilot pressure adaptor with check



## Proportional Sectional Valves – PVG32 Danfoss

### Select Working Section

#### PVB Basic Modules

##### Compensated PVB with LS A/B (157B6203 & 157B6233)

The compensated PVB is intended for controlling a work function where the function behaviour in terms of flow and pressures requires independency on the load pressure of other functions used simultaneously. The integrated LSA/B relief valve is used to limit the maximum work port build-up on the A/B-ports individually.



##### The compensated PVB with LSA/B features:

- Integrated LS shuttle network
- Integrated compensator
- Integrated adjustable LSA/B pressure relief valves
- External LSA/B port connection
- Integrated LSA/B shuttle valve for float spool usage
- Optional shock/anti-cavitation valve facility (PVLVP)
- Optional T0 facility

Compensated PVB with LS

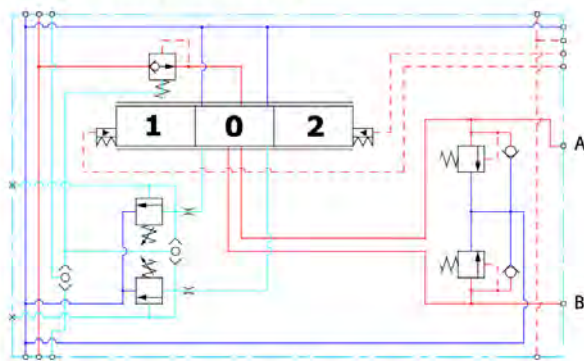

Compensated PVB with LS and T0

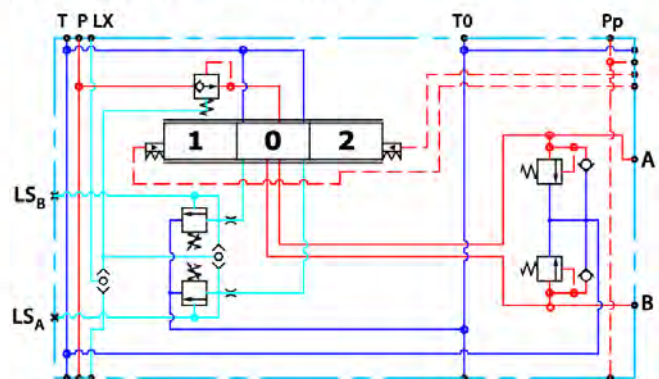

##### Compensated PVB (157B6230)

The compensated PVB is intended for controlling a work function where the function behaviour in terms of flow and pressures requires independence on the load pressure of other functions used simultaneously.

##### The Compensated PVB features:

- Integrated LS shuttle network
- Integrated compensator
- Optional shock/anti-cavitation valve facility (PVLVP)
- Optional T0 facility and external T0 port

Compensated PVB schematic

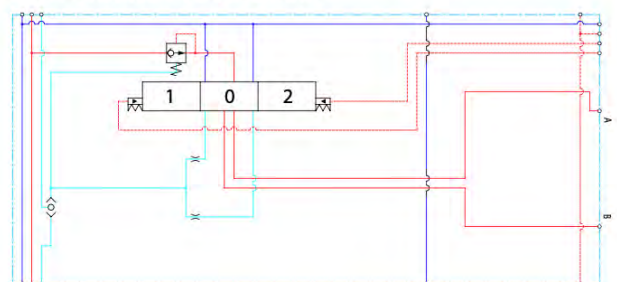

Code	Description
157B6203	Danfoss PVB section compensated & LS A/B no port reliefs 1/2" BSP
157B6230	Danfoss PVB section compensated port reliefs 1/2" BSP
157B6233	Danfoss PVB section compensated & LS A/B port reliefs 1/2" BSP

## Proportional Sectional Valves – PVG32 Danfoss

### Select Spool - PVBS Main Spools

The main spools (PVBS) determine the flow out of the work section or the pressure build up. The PVBS main spool can be activated in three different ways:

- Mechanically by a PVM lever
- Electrically by a PVE/PVHC actuator
- Hydraulically by a PVH actuator



PVBS main spool



PVBS main spool dimensions

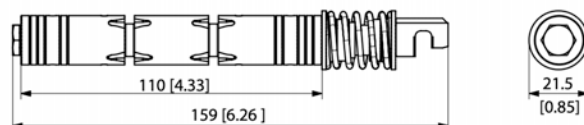

Weight: 0.25 kg [ 0.55 lb]

### Flow Control Spools—Closed Neutral Position

Schematic for PVBS without shuttle valve

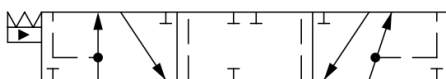

Schematic for PVBS with shuttle valve

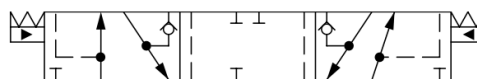

Code	Description
157B9005	Danfoss PVBS spool closed centre 5 lpm PVH/PVHC
157B9000	Danfoss PVBS spool closed centre 10 lpm PVH/PVHC
157B9001	Danfoss PVBS spool closed centre 25 lpm PVH/PVHC
157B9002	Danfoss PVBS spool closed centre 40 lpm PVH/PVHC
157B9003	Danfoss PVBS spool closed centre 65 lpm PVH/PVHC
157B9004	Danfoss PVBS spool closed centre 100 lpm PVH/PVHC
157B9006	Danfoss PVBS spool closed centre 130 lpm PVH/PVHC
157B9025	Danfoss PVBS spool closed centre 5 lpm PVH/PVHC with shuttle
157B9020	Danfoss PVBS spool closed centre 10 lpm PVH/PVHC with shuttle
157B9021	Danfoss PVBS spool closed centre 25 lpm PVH/PVHC with shuttle
157B9022	Danfoss PVBS spool closed centre 40 lpm PVH/PVHC with shuttle
157B9023	Danfoss PVBS spool closed centre 65 lpm PVH/PVHC with shuttle
157B9024	Danfoss PVBS spool closed centre 100 lpm PVH/PVHC with shuttle
157B9026	Danfoss PVBS spool closed centre 130 lpm PVH/PVHC with shuttle

- Note: Spools with shuttles are required for load sense on A & B ports

## Proportional Sectional Valves – PVG32 Danfoss

### Select Spool - PVBS Main Spools

The main spools (PVBS) determine the flow out of the work section or the pressure build up. The PVBS main spool can be activated in three different ways:



#### Flow Control Spools—Throttled Open Neutral Position

Schematic for PVBS without shuttle valve

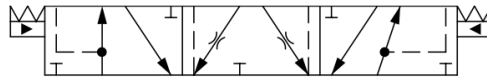

Code	Description
157B9105	Danfoss PVBS spool throttled open neutral position 5 lpm PVH/PVHC
157B9100	Danfoss PVBS spool throttled open neutral position 10 lpm PVH/PVHC
157B9101	Danfoss PVBS spool throttled open neutral position 25 lpm PVH/PVHC
157B9102	Danfoss PVBS spool throttled open neutral position 40 lpm PVH/PVHC
157B9103	Danfoss PVBS spool throttled open neutral position 65 lpm PVH/PVHC
157B9104	Danfoss PVBS spool throttled open neutral position 100 lpm PVH/PVHC
157B9106	Danfoss PVBS spool throttled open neutral position 130 lpm PVH/PVHC
157B9125	Danfoss PVBS spool throttled open neutral position 5 lpm PVH/PVHC with shuttle
157B9120	Danfoss PVBS spool throttled open neutral position 10 lpm PVH/PVHC with shuttle
157B9121	Danfoss PVBS spool throttled open neutral position 25 lpm PVH/PVHC with shuttle
157B9122	Danfoss PVBS spool throttled open neutral position 40 lpm PVH/PVHC with shuttle
157B9123	Danfoss PVBS spool throttled open neutral position 65 lpm PVH/PVHC with shuttle
157B9124	Danfoss PVBS spool throttled open neutral position 100 lpm PVH/PVHC with shuttle
157B9126	Danfoss PVBS spool throttled open neutral position 130 lpm PVH/PVHC with shuttle

- Note: Spools with shuttles are required for load sense on A & B ports

#### Single Acting Cylinder Flow Control Spools—Neutral A-port Position

Schematic for PVBS without shuttle valve

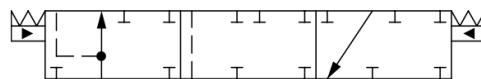

Code	Description
157B9200	Danfoss PVBS spool single acting on a port 10 lpm PVH/PVHC
157B9201	Danfoss PVBS spool single acting on a port 25 lpm PVH/PVHC
157B9202	Danfoss PVBS spool single acting on a port 40 lpm PVH/PVHC
157B9203	Danfoss PVBS spool single acting on a port 65 lpm PVH/PVHC
157B9204	Danfoss PVBS spool single acting on a port 100 lpm PVH/PVHC
11085447	Danfoss PVBS spool single acting on a port 130 lpm PVH/PVHC

## Proportional Sectional Valves – PVG32 Danfoss

### Select Working Section Options

#### PVB Basic Modules Accessories



#### PVLP Shock and Anti-Cavitation Valve

The PVLP shock and anti-cavitation valve will relieve a pressure peak to the internal tank galleries and will furthermore suck oil from the tank to the work port to prevent cavitation. Pressure settings range: 32–400 bar.

- The pressure setting of the PVLP must always be 20 bar higher than LSA/B setting in the same module.

#### PVLP schematic

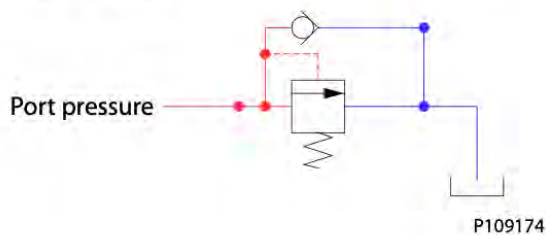

Code	Description
157B2050	Danfoss PVLP shock & anti-cavitation valve 50 bar
157B2063	Danfoss PVLP shock & anti-cavitation valve 63 bar
157B2080	Danfoss PVLP shock & anti-cavitation valve 80 bar
157B2100	Danfoss PVLP shock & anti-cavitation valve 100 bar
157B2125	Danfoss PVLP shock & anti-cavitation valve 125 bar
157B2140	Danfoss PVLP shock & anti-cavitation valve 140 bar
157B2160	Danfoss PVLP shock & anti-cavitation valve 160 bar
157B2175	Danfoss PVLP shock & anti-cavitation valve 175 bar
157B2190	Danfoss PVLP shock & anti-cavitation valve 190 bar
157B2210	Danfoss PVLP shock & anti-cavitation valve 210 bar
157B2230	Danfoss PVLP shock & anti-cavitation valve 230 bar
157B2240	Danfoss PVLP shock & anti-cavitation valve 240 bar
157B2250	Danfoss PVLP shock & anti-cavitation valve 250 bar
157B2265	Danfoss PVLP shock & anti-cavitation valve 265 bar
157B2280	Danfoss PVLP shock & anti-cavitation valve 280 bar
157B2300	Danfoss PVLP shock & anti-cavitation valve 300 bar
157B2320	Danfoss PVLP shock & anti-cavitation valve 320 bar
157B2350	Danfoss PVLP shock & anti-cavitation valve 350 bar
157B2365	Danfoss PVLP shock & anti-cavitation valve 365 bar
157B2380	Danfoss PVLP shock & anti-cavitation valve 380 bar
157B2400	Danfoss PVLP shock & anti-cavitation valve 400 bar

## Proportional Sectional Valves – PVG32 Danfoss

### Select Working Section Options



#### PVB Basic Modules Accessories

##### PVLA Suction Valve / Anti-cavitation

The PVLA valve is an accessory available for PVB basic modules.

The PVLA will suck fluid from the tank to the work port to prevent cavitation by the 0.5 bar spring. The plug will ensure that when using a single acting spool, all flow returning through the work port is led to tank.

PVLA schematic

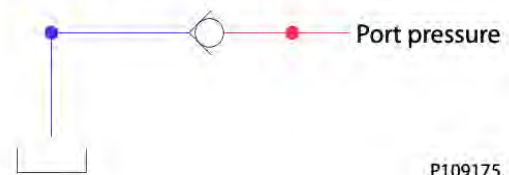

P109175

##### PVM Manual Actuation

The PVM manual actuation cover is intended for use on any work section where the operator has to have the ability to interact with the spool manually. The PVM variants are based on a generic platform with a selection of additional features, enabling you to tailor the PVM to suit the demands of any hydraulic system, which includes the following main variants:

- PVM manual actuation or override of a function
- Spring centre cover without manual override (PVML)
  - Optional with lever base
  - Optional with lever base and lever
  - Optional flow adjustment screws
- The adjustment screws are intended for limiting the spool travel and thereby the maximum achievable flow.



Code	Description
157B2001	Danfoss PVLA anti-cavitation valve A/B port
157B2002	Danfoss PVLA anti-cavitation valve plug A/B port
157B3171	Danfoss PVM mechanical activation
157B0001	Danfoss PVMD cover for PVM for use in mechanically activated sections



## Proportional Sectional Valves – PVG32 Danfoss

### Select Working Section Options

#### PVB Basic Modules Accessories

#### PVH Hydraulic Actuation

The PVH hydraulic actuation is intended for use on any work section where the operator wants to have a possibility to interact with the main spool via a hydraulic joystick. The spool spring package must match with this activation method. ¼” BSPP ports.



PVH cover



#### Technical data

<b>Main spool spring control pressure range</b>	5 – 15 bar [73 – 218 psi]
<b>Operating torque from neutral</b>	2.5 ±0.2 N·m [22.1±1.8 lb·in]
<b>Operating torque max spool position</b>	6.9 ±0.2 N·m [61.0±1.8 lb·in]
<b>Maximum pilot oil pressure</b>	30 bar [435 psi]

Code	Description
157B0008	Danfoss PVH hydraulic activation

#### PVE Electro-hydraulic Actuation - PVEO-HP

The PVEO-HP actuator is a non-proportional ON/OFF control actuator with open-loop spool control primarily used to control simple ON/OFF work functions where a proportional control of speed or oil flow is not a requirement.



#### PVHC Electro-Hydraulic Actuation

The PVHC is an electrical actuator module for main spool control. The PVHC control is done by dual Pulse Width Modulated, high current supply 100-400 Hz PWM control signals. The spool position will shift when conditions are changed such as temperature change.

- Inlet with Hydraulic Pilot Pressure is needed.

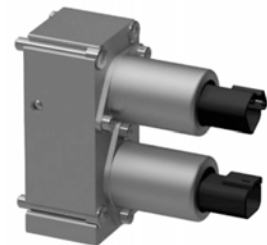

Code	Description
11166765	Danfoss PVEO-HP electro-hydraulic actuator on/off 12VDC deutsch
11166766	Danfoss PVEO-HP electro-hydraulic actuator on/off 24VDC deutsch
11112038	Danfoss PVHC electro-hydraulic actuator proportional PWM 12VDC deutsch
11112039	Danfoss PVHC electro-hydraulic actuator proportional PWM 24VDC deutsch

## Proportional Sectional Valves – PVG32 Danfoss



### Select Outlet & Tie Rod Kit

#### PVS End Plates

The PVG 32 PVS end plates are placed at the end the valve stack section. Furthermore, the end plate is ensuring Load Sense (LS) is relieved to tank pressure when the valve is not operated. The LX port enables other remote valves to be connected onto the Load Sense shuttle network.

- The end plates are made of either aluminium (300 bar) or cast iron (350 bar) material.

Code	Description
157B2000	Danfoss PVS end plate without connections - Al
157B2011	Danfoss PVS end plate with LX connection - Al
157B2014	Danfoss PVS end plate without connections - cast iron
157B2015	Danfoss PVS end plate with LX connection - cast iron

#### PVAS Stay Bolts / Tie Rods

PVAS Stay Bolts kit for various PVG combinations consist of three tie rods, six washers, six nuts and O-ring. The tie rods are inserted through the entire length of the PVG valve stack. The nuts are tightened at the pump side and at the end plate.

Code	Description
157B8001	Danfoss PVAS tie rod kit PVG16 & PVG32 1 bank torque 28 nm
157B8002	Danfoss PVAS tie rod kit PVG32 2 bank torque 28 nm
157B8003	Danfoss PVAS tie rod kit PVG32 3 bank torque 28 nm
157B8004	Danfoss PVAS tie rod kit PVG32 4 bank torque 28 nm
157B8005	Danfoss PVAS tie rod kit PVG16 6 bank & PVG32 5 bank torque 28 nm
157B8006	Danfoss PVAS tie rod kit PVG16 7 bank & PVG32 6 bank torque 28 nm
157B8007	Danfoss PVAS tie rod kit PVG32 7 bank torque 28 nm
157B8008	Danfoss PVAS tie rod kit PVG32 8 bank torque 28 nm
157B8009	Danfoss PVAS tie rod kit PVG32 9 bank torque 28 nm
157B8010	Danfoss PVAS tie rod kit PVG32 10 bank torque 28 nm
157B8061	Danfoss PVAS tie rod kit PVG32 11 bank torque 28 nm
157B8062	Danfoss PVAS tie rod kit PVG32 12 bank torque 28 nm

### Seal Kits

Code	Description
11061235	Danfoss PVHC electrical actuator seal kit
157B4997	Danfoss PVEO PVEM PVEP PVEA PVEH PVES actuator seal kit
157B8999	Danfoss PVG32 seal kit 1 work section
11156335	Danfoss PVG32 seal kit 7 work sections

## Diverter / Selector Valves - Walvoil



### 3 & 6 Port, Rotary Lever Action - (open on change over).

Model	Description	Max. Flow <i>lpm</i>	Max. Press. <i>bar</i>
DH5/3A	3 Port, 3/8" BSP	60	315
DH10/3A	3 Port, 1/2" BSP	90	315
DH20/3A	3 Port, 3/4" BSP	140	315
DH25/3A	3 Port, 1" BSP	200	250
DH5/4A	4 Port 3/8" BSP	60	315
DH10/4A	4 Port 1/2" BSP	90	315
DH20/4A	4 Port 3/4" BSP	140	315
DH25/4A	4 Port 1" BSP	200	250
DH5/6A	6 Port, 3/8" BSP	60	315
DH10/6A	6 Port, 1/2" BSP	90	315
DH20/6A	6 Port, 3/4" BSP	140	315
DH25/6A	6 Port, 1" BSP	200	250



### 3 & 6 Port, Push Pull Lever Action - (open on change over).

Model	Description	Max. Flow <i>lpm</i>	Max. Press. <i>bar</i>
DF5/3A12L	3 Port, 3/8" BSP, detent	60	315
DF5/3A17L	3 Port, 3/8" BSP, spring return	60	315
DF10/3A12L	3 Port, 1/2" BSP, detent	90	315
DF10/3A17L	3 Port, 1/2" BSP, spring return	90	315
DF20/3A12L	3 Port, 3/4" BSP, detent	140	315
DF20/3A17L	3 Port, 3/4" BSP, spring return	140	315
DF5/6A12L	6 Port, 3/8" BSP, detent	60	315
DF5/6A17L	6 Port, 3/8" BSP, spring return	60	315
DF10/6A12L	6 Port, 1/2" BSP, detent	90	315
DF10/6A17L	6 Port, 1/2" BSP, spring return	90	315
DF20/6A12L	6 Port, 3/4" BSP, detent	140	315
DF20/6A17L	6 Port, 3/4" BSP, spring return	140	315



## Diverter / Selector Valves - Poclairn Hydraulics



### Electrical, 12 or 24 VDC - (open on change over)

- 3 and 6-way electrical selectors.
- Pressures up to 350 bar and flows up to 250 l/min with BSP ports.

Code	Model	Description	Drain Port	Max. Flow lpm	Max. Press bar
1607103	KVC-3/2-10-41B-12DC-3/8-S20	3 Port, 3/8" BSP, 12VDC	No	60	250
1607121	KVC-3/2-10-41B-3/8-S20 24VDC	3 Port, 3/8" BSP, 24VDC	No	60	250
1635379	KVC-3/2-10-41B-12DC-1/2-S20	3 Port, 1/2" BSP, 12VDC	No	60	250
1607111	KVC-3/2-10-41B-1/2-S20 24VDC	3 Port, 1/2" BSP, 24VDC	No	60	250
4010176	KVC-3/2-10-41B-12DC-3/4-YZ	3 Port, 3/4" BSP, 12VDC	1/4" BSP	100	350
4009706	KVC-3/2-10-41B-3/4-YZ 24VDC	3 Port, 3/4" BSP, 24VDC	1/4" BSP	100	350
4002882	KV-6/2-6-12DC-3/8-YZ-S50	6 Port, 3/8" BSP, 12VDC	1/4" BSP	50	350
4003799	KV-6/2-6-3/8-YZ-S50 24VDC	6 Port, 3/8" BSP, 24VDC	1/4" BSP	50	350
4002475	KV-6/2-6-12DC-1/2-YZ-S50	6 Port, 1/2" BSP, 12VDC	1/4" BSP	50	350
4003335	KV-6/2-6-1/2-YZ-S50 24VDC	6 Port, 1/2" BSP, 24VDC	1/4" BSP	50	350
4006970	KV-6/2-10-12DC-1/2-YZ-S40	6 Port, 1/2" BSP, 12VDC	1/4" BSP	120	350
4006969	KV-6/2-10-1/2-YZ-S40 24VDC	6 Port, 1/2" BSP, 24VDC	1/4" BSP	120	350
1636308	KV-6/2-10-12DC-3/4-YZ-S40	6 Port, 3/4" BSP, 12VDC	1/4" BSP	120	350
1613057	KV-6/2-10-3/4-YZ-S40 24VDC	6 Port, 3/4" BSP, 24VDC	1/4" BSP	120	350
4008379	KV-6/2-16-XN-G1 24VDC	6 Port, 1" BSP, 24VDC	1/4" BSP	250	15 - 350
4005077	KV-8/3-6-12DC3/8-S40	8 Port, 3/8" BSP, 12VDC	No	50	250
1561154	KV-8/3-6-3/8-S40 (24VDC)	8 Port, 3/8" BSP, 24VDC	No	50	250
1547437	KV-8/3-6-12DC1/2-S40	8 Port, 1/2" BSP, 12VDC	No	50	250
1547429	KV-8/3-6-1/2-S40 (24 VDC)	8 Port, 1/2" BSP, 24VDC	No	50	250

### Spare Components

Code	Description
1615955N	COIL 24VDC KV-6/2-6
1615963N	COIL 12VDC KV-6/2-6
1569449N	COIL 24VDC KV-6/2-10
1590693N	COIL 12VDC KV-6/2-10
4014831	SEAL KIT KV-6/2-6
4015219	SEAL KIT KV-6/2-10

## Diverter / Selector Valves - Walvoil Hydraulics

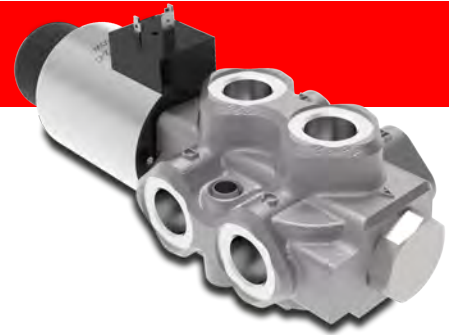

### Electrical, 12 or 24 VDC - (open on change over)

- 6-way electrical selectors.
- \* Max. pressure 200 bar with 1/4" drain port blocked.

Code	Model	Description	Drain Port 1/4" bsp	Max. Flow lpm	Max. Press* bar
12Z270092	DFE052/6A-18ES-Y201-12VDC	6 Port, 3/8" BSP, 12VDC	Yes	60	315
12Z270141	DFE052/6A-18ES-Y201-24VDC	6 Port, 3/8" BSP, 24VDC	Yes	60	315
12Z470017	DFE102/6A-18ES-Y202-12VDC	6 Port, 1/2" BSP, 12VDC	Yes	90	315
12Z470015	DFE102/6A-18ES-Y202-24VDC	6 Port, 1/2" BSP, 24VDC	Yes	90	315
12Z670013	DFE20/6A-18ES-Y200-12VDC	6 Port, 3/4" BSP, 12VDC	Yes	140	315
12Z670012	DFE20/6A-18ES-Y200-24VDC	6 Port, 3/4" BSP, 24VDC	Yes	140	315

### Spare Components

Code	Description
4SOL515012	12 VDC D15 Coil for DFE052
4SOL515024	24 VDC D15 Coil for DFE052
4SOL516012	12 VDC D19 Coil for DFE102
4SOL516024	24 VDC D19 Coil for DFE102
4SOL519112	12 VDC D19 Coil for DFE20
4SOL519124	24 VDC D19 Coil for DFE20

## Flow Controls - Brand Hydraulics



### Manual 3 Port Priority Flow Controls

- Pressure compensating variable 3 port flow controls with optional relief valve. Both regulated and bypass ports are pressure compensated. Rotary lever adjustment. Cast iron construction.

Model	Description	Reg Flow <i>lpm</i>	Max. Pressure <i>bar</i>
FC51-8SS	3/4" UNO	0 - 30	207
FC51-10SS	7/8" UNO	0 - 60	207
FC51-12SS	1 1/16" UNO	0 - 114	207
FCR51-8SS	3/4" UNO c/w Relief	0 - 30	207
FCR51-10SS	7/8" UNO c/w Relief	0 - 60	207
FCR51-12SS	1 1/16" UNO c/w Relief	0 - 114	207

## Flow Controls – Tognella



### 2 Port In Line, High Pressure Needle Valve

Model	Description	Flow Rate <i>lpm</i>	Max. Pressure <i>bar</i>
FT257/2-14-MP	1/4" BSP	15	400
FT257/2-38-MP	3/8" BSP	30	400
FT257/2-12-MP	1/2" BSP	50	400
FT257/2-34-MP	3/4" BSP	80	400
FT257/2-100-MP	1" BSP	150	400



### 2 Port In Line, High Pressure, Free Reverse Flow Needle Valve

Model	Description	Flow Rate <i>lpm</i>	Max. Pressure <i>bar</i>
FT257/5-14	1/4" BSP	15	400
FT257/5-38	3/8" BSP	30	400
FT257/5-12	1/2" BSP	50	400
FT257/5-34	3/4" BSP	80	400
FT257/5-100	1" BSP	150	400

### 2 Port In Line, Pressure Compensated with Free Reverse, Flow Control

- Pressure compensated valves with free reverse flow check & BSP ports
- Adjustable pressure compensated flow control valves allow for versatility where flow cannot be predetermined or where continual flow adjustment is required.
- The valves are virtually unaffected by changes in pressure & have low hysteresis



Model	Description	Flow Rate <i>lpm</i>	Max. Pressure <i>bar</i>
FT270/5-14	1/4" BSP	4 - 15	210
FT270/5-38	3/8" BSP	5 - 25	210
FT270/5-12	1/2" BSP	15 - 50	210
FT270/5-34	3/4" BSP	10 - 80	210
FT270/5-100	1" BSP	10 - 138	210

## Flow Controls - Tognella



### 2 Port In Line, Brass Forged, Needle Valve

Model	Description	Flow Rate <i>lpm</i>	Max. Pressure <i>bar</i>
FT1251/2-01-14	1/4" BSP	15	210
FT1251/2-01-38	3/8" BSP	30	210
FT1251/2-01-12	1/2" BSP	50	210
FT1251/2-01-34	3/4" BSP	78	210



### 2 Port, In Line, Brass Forged, Free Reverse Flow, Needle Valve

Model	Description	Flow Rate <i>lpm</i>	Max. Pressure <i>bar</i>
FT1251/5-01-14	1/4" BSP	15	210
FT1251/5-01-38	3/8" BSP	30	210
FT1251/5-01-12	1/2" BSP	50	210



### 2 Port, 90°, Brass Forged, Needle Valve

Model	Description	Flow Rate <i>lpm</i>	Max. Pressure <i>bar</i>
FT1252/2-01-38	3/8" BSP	30	210
FT1252/2-01-12	1/2" BSP	50	210



### 2 Port, 90°, Brass Forged, Free Reverse Flow, Needle Valve

Model	Description	Flow Rate <i>lpm</i>	Max. Pressure <i>bar</i>
FT1254/5-01-38	3/8" BSP	30	210
FT1254/5-01-12	1/2" BSP	50	210

## Gauge Isolators - Tognella



### Gauge Isolator, Needle Valve

Model	Description	Max. Pressure bar
FT290-14	1/4" BSP, male/female	400
FT290-01-14	1/4" BSP, female/female	400

### Gauge Isolator, Push Button



Model	Description	Max. Pressure bar
FT292	1/4" BSP	400

## Stainless Steel Valves

### 2 Way Ball Valves



Model	Description	Max. Pressure bar
FT2221/1-3000-38	Stainless Steel 3/8" BSP	500
FT2221/1-3000-12	Stainless Steel 1/2" BSP	500

### Needle Valve



Model	Description	Flow Rate lpm	Max. Pressure bar
FT2251/2-01-38	Stainless Steel 3/8" BSP	30	210
FT2251/2-01-12	Stainless Steel 1/2" BSP	50	210

### 2-Port PC Flow Control



Model	Description	Flow Rate lpm	Max. Pressure bar
FT2270/2-38	Stainless Steel 3/8" BSP	25	210
FT2270/2-12	Stainless Steel 1/2" BSP	50	210

## Ball Valves - Tognella



### 2 Way Ball Valves

Model	Description	Max. Pressure bar
FT221/1-14	1/4" BSP	500
FT221/1-38	3/8" BSP	500
FT221/1-12	1/2" BSP	500
FT221/1-34	3/4" BSP	320
FT221/1-100	1" BSP	320
FT221/1-114	1 1/4" BSP	320



### 3 Way Ball Valves

Model	Description	Max. Pressure bar
FT221/3-14	1/4" BSP	500
FT221/3-38	3/8" BSP	500
FT221/3-12	1/2" BSP	500
FT221/3-34	3/4" BSP	320
FT221/3-100	1" BSP	320
FT221/3-114	1 1/4" BSP	320

### In Line Check Valves - 0.35 Bar Spring



Model	Description	Max. Pressure bar
FT260/6-18	1/8" BSP	400
FT260/6-14	1/4" BSP	400
FT260/6-38	3/8" BSP	400
FT260/6-12	1/2" BSP	400
FT260/6-34	3/4" BSP	400
FT260/6-100	1" BSP	400
FT257/6-114	1 1/4" BSP	320

### In Line Check Valves - 4.5 / 4.0 Bar Spring

Model	Description	Max. Pressure bar
FT260/6-12-4.5	1/2" BSP	350
FT260/6-34-4.5	3/4" BSP	350
FT260/6-100-4.5	1" BSP	350
FT257/6-114-4.0	1 1/4" BSP	320
FT257/6-112-4.0	1 1/2" BSP	320

## Reciprocating Valve – Poclairn Hydraulics

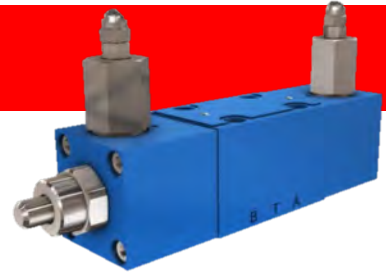

- Mounts onto a standard Cetop 5.
- This is a double acting valve, which automatically changes over the oil flow direction. The motion is completely automatic and normally takes place when the cylinder reaches its end of stroke.

Model	Description	Flow Rate <i>lpm</i>	Pressure Range <i>bar</i>
1219936	Auto reciprocating Cetop 5 valve PKV-10	1-60	50 - 210



## Contents Section E – Hydraulic Power Packs

### **E1 Hydraulic Power Packs**

E1	AC / DC Modular Micro Power Pack	<i>OMT</i>
E3	AC / DC Power Pack	<i>Bucher (Deli)</i>
E4	3-Phase Hyspecs Standard Power Packs	<i>Hyspecs</i>

## AC / DC Modular Micro Power Pack - OMT



- Modular Micro AC / DC power pack.
- Allows easy assembly of a small size power unit when using standard Galtech group 1 gear pumps.
- Suits size 80/90 AC electric motors up to 3 kW
- DC electric motors up to 3 kW



### Step 1. Use the following standard adaptors

Model	Description
P200	Foot flange
BC20-V3-U1P	OMT bell housing with integral check and relief valve (70-315 bar)

### Step 2. Choose your porting adaptor

Model	Description
M	OMT manifold P & T ports - BC20
PM06-F	OMT manifold Cetop 3 - BC20 <b>(select a Cetop 3 to suit)</b>
PM	OMT Manifold Solenoid Dump BC20 (doesn't include solenoid valve)

### Step 3. Choose your group 1 Galtech gear pump

Model	Displacement <i>cc/rev</i>	Max. Cont. Pressure <i>bar</i>	Max. Speed <i>rpm</i>
1SP-A-090-D-EUR-B-N-10-0-N	0.89	260	6000
1SP-A-012-D-EUR-B-N-10-0-N	1.18	260	6000
1SP-A-016-D-EUR-B-N-10-0-N	1.6	260	6000
1SP-A-020-D-EUR-B-N-10-0-N	2.0	260	5500
1SP-A-025-D-EUR-B-N-10-0-N	2.5	260	5000
1SP-A-032-D-EUR-B-N-10-0-N	3.2	260	4500
1SP-A-037-D-EUR-B-N-10-0-N	3.7	250	4000
1SP-A-042-D-EUR-B-N-10-0-N	4.2	250	3500
1SP-A-050-D-EUR-B-N-10-0-N	5.0	250	3000
1SP-A-063-D-EUR-B-N-10-0-N	6.3	170	2700
1SP-A-078-D-EUR-B-N-10-0-N	7.76	170	2500

### Step 4. Choose your electric motor and adaptor

Model	Description
-	No adaptor required for AC motor
<b>Use size 80/90 AC electric motors 0.55-1.55 kW standard. 2.2 - 3 kW AC check availability. Up to 3 kW DC.</b>	

## AC / DC Modular Micro Power Pack – OMT



### Step 5. Select a coupling to suit

Model	Description
ND 5	To suit size 80 frame AC electric motor to group 1 pump
ND 70A	To suit size 90 frame AC electric motor to group 1 pump

### Step 6. Select a tank to suit

Model	Description
SC7-224	OMT oil tank 7 litres
SC10-224	OMT oil tank 10 litres

### Step 7. Use the following standard filtration

Model	Description
F-01	OMT return filter
OMT HOSE KIT	Hose kit for modular power pack

## AC / DC Power Pack – Bucher



- Pre-assembled, economic power pack
- 12 VDC 2.0 kW & 24 VDC 2.2 kW motors; 3, 5 & 8 litre tanks
- 2.1 cc/rev pump
- Single acting or CETOP circuits
- Complete wired remote control
- **Hydraulic Dock Leveller Power Packs**, single or three phase power
  - One button version, factory standard. The one button unit automatically controls the ramp up/down and the lip up/down through a type of sequence valve.
  - Two-button version which includes a custom manifold designed and manufactured by Hyspecs. The two-button version works the same way but gives the operator an option to operate the lip individually when required.

**NB: Select the model power pack you want and then add a solenoid valve and coil or Cetop valve to get the full assembly. Oil is not included.**

Model	Description
F2.1A1A0WUAOD1R	12VDC 2.0 kW 3l tank 2.1 cc Single Acting & Remote
F2.1A2M0WUAOD1R	24VDC 2.2 kW 3l tank 2.1 cc Single Acting & Remote
F2.1A1A0WUAOC1R	12VDC 2.0 kW 3l tank 2.1 cc CETOP Pad & Remote
F2.1B1A0WUAOD1R	12VDC 2.0 kW 5l tank 2.1 cc Single Acting & Remote
F2.1B2M0WUAOD1R	24VDC 2.2 kW 5l tank 2.1 cc Single Acting & Remote
F2.1B2M0WUAOC1R	24VDC 2.2 kW 5l tank 2.1 cc CETOP Pad & Remote
F2.1B1A0WUAOC1R	12VDC 2.0 kW 5l tank 2.1 cc CETOP Pad & Remote
F2.1C1A0WUAOC1R	12VDC 2.0 kW 8l tank 2.1 cc CETOP Pad & Remote
F2.1C1A0WUAOD1R	12VDC 2.0 kW 8l tank 2.1 cc Single Acting & Remote
F2.1C2M0WUAOD1R	24VDC 2.2 kW 8l tank 2.1 cc Single Acting & Remote
YBZ5-D3.7B3F80CBAOT1	Dock Leveller type 3 240v 1ph 1.1kw 6l tank 3.7 cc
YBZ5-D3.7B4F80CBAOT1	Dock Leveller type 3 380v 3ph 1.1kw 6l tank 3.7 cc

Spare Components	Description
SV08-20-0-N-0	Single acting solenoid valve
SV08-20M-0-N-0	Single acting solenoid valve with manual override
6302012	12 VDC coil with flying leads
6302024	24 VDC coil with flying leads
6306012	12 VDC coil with DIN plug
6306024	24 VDC coil with DIN plug
SWH-G02-B* -***	Cetop 3 Single solenoid, 2 position, 12 or 24 VDC
SWH-G02-C*B-***	Cetop 3 Single solenoid, 2 position, 12 or 24 VDC
SWH-G02-C* -***	Cetop 3 Double solenoid, 3 position, 12 or 24 VDC
CBK-F1.6F	Gear Pump 1.6 cc
CBK-F2.1F	Gear Pump 2.1 cc
CBK-F3.7F	Gear Pump 3.7 cc
CBK-F6.0F	Gear Pump 6.0 cc
DM21-1AWU-3BC1RB	DC Motor 12 VDC 2kW with Thermal Overload
DM22-2MWU-3BA1R	DC Motor 24 VDC 2.2kW with Thermal Overload
RC-2B3L3M	Remote Control for Single Acting Power Pack
RC-2B4L3M	Remote Control for Double Acting Power Pack
634-24C1-212-09	Start Solenoid 24VDC, new style
634-12C1-212-09	Start Solenoid 12VDC, new style

\* indicates spool type and coil voltage – *contact Hyspecs*

## Hyspecs Standard Powerpacks

- Tanks range from 25 to 200 litres, in aluminium.
- 3 phase electric motors 2.2 kW to 15 kW.
- Fixed displacement gear or vane pump.
- Stacking manifolds can be bolted onto the P&T subplate so you can have up to four cetop 3 or cetop 5 valves. It's possible to mix cetop 3 and cetop 5 on the same stack.
- Comes with sight level gauge, filler breather, return filter, pressure and tank line connection manifold with built in adjustable relief valve and test point.
- Configurable up to four Cetop valves with unloading valve built into base manifold.
- Optional electrical kit which includes motor start/stop control box, 5 meter power lead with plug, tested and tagged.
- Hyspecs manufactured hydraulic manifolds.
- Hyspecs Assembled & tested.



### Gear (GP) & Vane (VP) Pump Power Packs

Tank Usable Volume	3-Phase Electric Motor						
	2.2 kW	3 kW	4 kW	5.5 kW	7.5 kW	11 kW	15 kW
25 L	HSP 1 GP HSP 1 VP	HSP 2 GP HSP 2 VP					
33 L		HSP 3 GP HSP 3 VP	HSP 4 GP HSP 4 VP				
52 L			HSP 5 GP HSP 5 VP	HSP 6 GP HSP 6 VP	HSP 7 GP HSP 7 VP		
100 L				HSP 8 GP HSP 8 VP	HSP 9 GP HSP 9 VP	HSP 10 GP HSP 10 VP	
150 L						HSP 11 GP HSP 11 VP	HSP 12 GP HSP 12 VP
200 L							HSP 13 GP HSP 13 VP

Price Adder Valves		Price Adder Motor Starter	
Additional valve config, excludes control modules		Electrical start/stop with 5m lead and plug	
1 x Cetop 3	\$ POA	2.2 kW	\$ POA
2 x Cetop 3	\$ POA	3 kW	\$ POA
2 x Cetop 3	\$ POA	4 kW	\$ POA
4 x Cetop 3	\$ POA	5.5 kW	\$ POA
1 x Cetop 5	\$ POA	7.5 kW	\$ POA
2 x Cetop 5	\$ POA	11 kW	\$ POA
3 x Cetop 5	\$ POA	15 kW	\$ POA
4 x Cetop 5	\$ POA		

## Hyspecs Standard Powerpacks

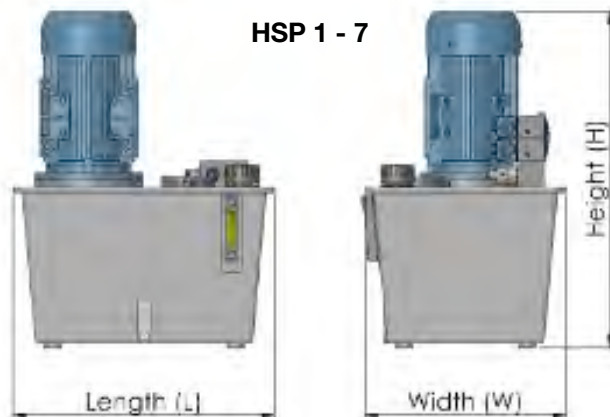
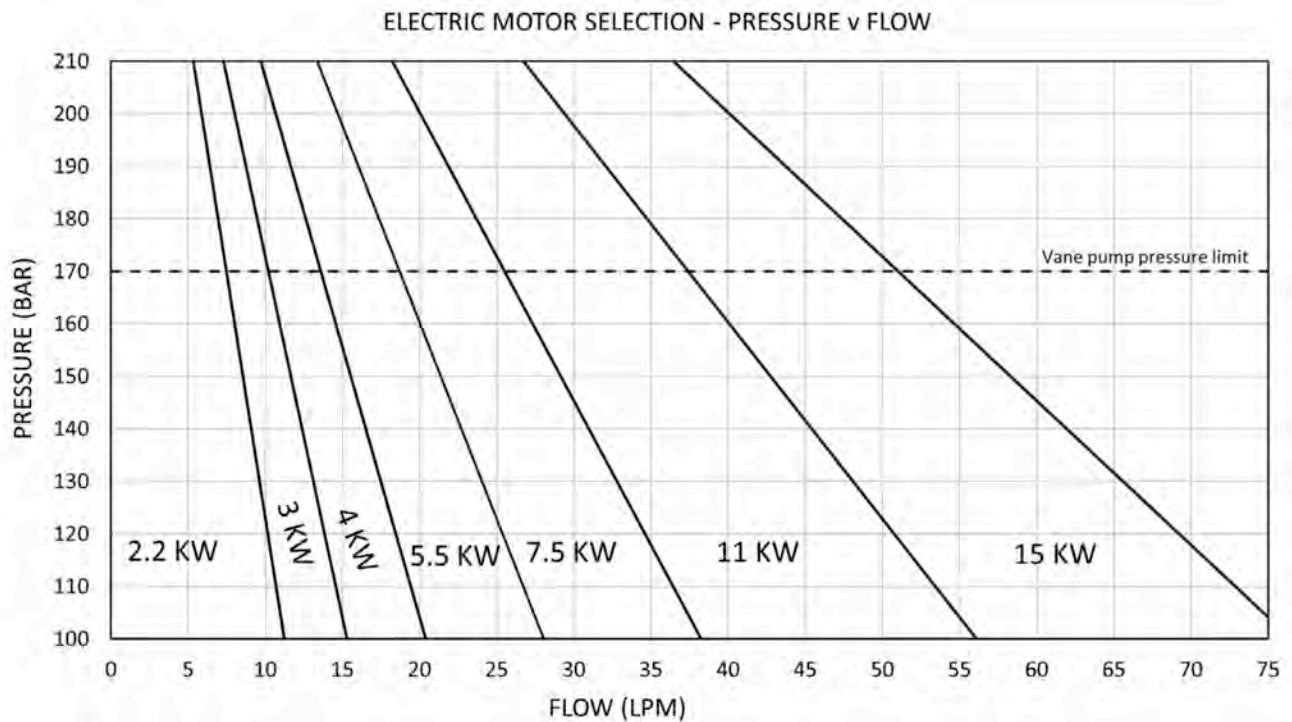

Dimensions			
Kit Set #	Length mm	Width mm	Height mm
HSP 1	490	340	650
HSP 2	490	340	650
HSP 3	515	415	680
HSP 4	515	415	730
HSP 5	605	465	780
HSP 6	605	465	790
HSP 7	605	465	830
HSP 8	780	450	925
HSP 9	780	450	960
HSP 10	780	450	1030
HSP 11	880	500	1080
HSP 12	880	500	1130
HSP 13	980	500	1230

- 3D Models Available on request
- Circuit Drawing available on request
- For custom configuration and system design, contact Hyspecs
- Cetop 5 only available on HSP 8-13

## Contents Section F – Power Steering

<b>F1</b>	<b>Power Steering Units</b>	
F1	OSPB ON Series	<i>Danfoss</i>



## Power Steering Units - Danfoss



### OSPB ON series, Open Centre, Non-Reaction

- Open centre steering units have an open connection between pump and tank in the neutral position. In open centre steering systems, pumps with fixed displacement are used.
- With non-reaction steering units there is no corresponding movement of the steering wheel when the driver is not steering the vehicle.

### Specifications

Model	Code	Displacement cc/rev	Oil Flow l/min	P bar	T bar	L,R bar
150N0026	OSPB 80 ON	80	8-30	175	40	280
150N0027	OSPB 100 ON	100	10-30	175	40	280
150N0024	OSPB 125 ON	125	13-50	210	40	280
150N0028	OSPB 160 ON	160	16-50	210	40	280
150N0023	OSPB 200 ON	200	20-50	210	40	280
150N0022	OSPB 250 ON	250	25-50	210	40	280
150N0030	OSPB 315 ON	315	32-70	210	40	280
150N0031	OSPB 400 ON	400	40-70	210	40	280
150N0032	OSPB 500 ON	500	50-70	210	40	280
150N4040	Seal Kit for Danfoss OSPB Steering Unit					

Type	mm L <sub>1</sub> [in]	mm L <sub>2</sub> [in]
OSPB 50	126 [4.96]	6.5 [0.26]
OSPB 80	129 [5.08]	10.4 [0.41]
OSPB 100	132 [5.20]	13.0 [0.51]
OSPB 125	135 [5.31]	16.2 [0.64]
OSPB 160	140 [5.51]	20.8 [0.82]
OSPB 200	145 [5.71]	26.0 [1.02]
OSPB 250	151 [5.94]	32.5 [1.28]
OSPB 315	160 [6.30]	40.9 [1.61]
OSPB 400	171 [6.73]	52.0 [2.05]
OSPB 500	184 [7.24]	65.0 [2.56]

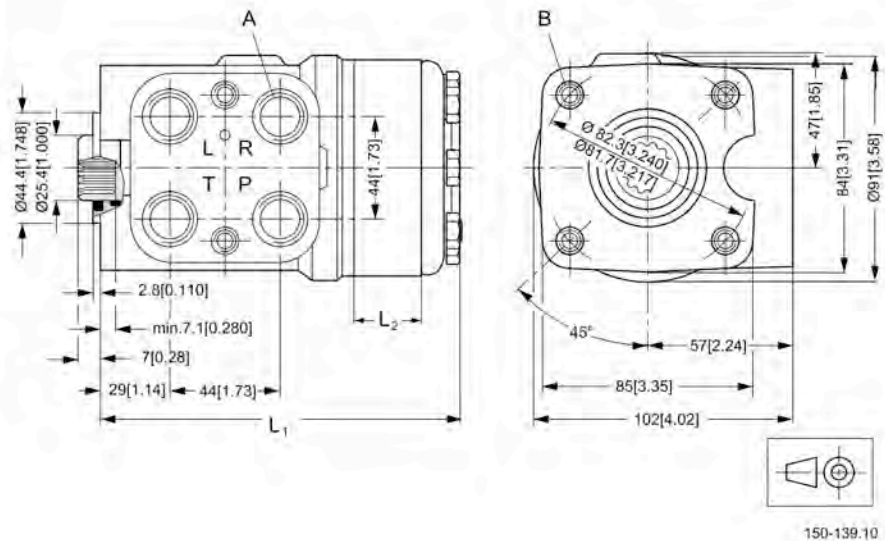

European version:  
 A: G ½; 15 mm [0.59 in] deep  
 B: M10 × 1.5,  
 16 mm [0.63 in] deep

US version:  
 A: ¾ - 16 UNF O-ring boss;  
 15 mm [0.59 in] deep  
 B: ¾ - 16 UNC,  
 16 mm [0.63 in] deep

## Contents Section G - Filtration

### G1 Filtration – Return

G1	OMTF Series – Tank Top, LP	OMT
G1	AFR Series – Tank Top, LP	OMT
G2	OMTI Series – In-Line spin on, LP	OMT
G2	OMTI Series – Indicators	OMT

### G3 Filtration – Medium Pressure

G3	APM Series – In-Line, MP	OMT
G3	APM Series – Indicators	OMT

### G4 Filtration – High Pressure

G4	HPM Series – In-Line, HP	OMT
G4	HPM Series – Indicators	OMT

### G5 Filtration - Suction

G5	SF Series - Suction	OMT
----	---------------------	-----

### G5 Filtration Accessories

G5	TRM Series – Tank Breathers	OMT
G5	TR Series - Filler Breathers	OMT
G6	PT-M5 Breather Adaptors	OMT
G6	T.R.A.P. Breathers	Donaldson

## Filtration - Return



- Lightweight filters to set in tank top with a detachable lid to remove the element.
- Oil return port in side.
- Operating pressure @ 3 bar, by-pass set @ 1.7 bar.

### Return, Tank Mounted - Low Pressure – OMT

#### OMTF Series – Tank Mounted – Return Port In Side At Top

OMT Model	Donaldson Equiv	Description	Port BSPP	Micron Nominal	Rated Flow lpm
OMTF091C10NA	FIO 30/1	Ø 66 mm hole	1/2"	10	40
OMTF111C10NA1	FIO 60/1	Ø 86 mm hole	3/4"	10	80
OMTF112C10NA2	FIO 100/1	Ø 86 mm hole	1"	10	100
OMTF171C10NA1	FIO 180/1	Ø 129 mm hole	1 1/4"	10	200
OMTF221C10NA1	FIO 250/1	Ø 173 mm hole	1 1/2"	10	276
OMTF223C10NA2	FIO 500/1	Ø 173 mm hole	2"	10	319



#### AFR Series – Tank Mounted – Return Port In Side At Bottom

OMT Model	Donaldson Equiv	Description	Port BSPP	Micron Nominal	Rated Flow lpm
AFR30C10NR	FIR 30/1	Ø 80 mm hole	1/2"	10	16
AFR60C10NR	FIR 60/1	Ø 106 mm hole	3/4"	10	49
AFR100C10NR	FIR 100/1	Ø 106 mm hole	1"	10	85
AFR180C10NR	FIR 180/1	Ø 147 mm hole	1 1/4"	10	150

#### Elements

OMT Model	Donaldson Equiv	Micron Nominal	Rated Flow lpm
CR091C10R	CR 30/1	10	40
CR091F10R	CR 30/02	10 absolute	27
CR111C10R	CR 60/1	10	80
CR111F10R	CR 60/02	10 absolute	39
CR112C10R	CR 100/1	10	100
CR112F10R	CR 100/02	10 absolute	55
CR171C10R	CR 180/1	10	200
CR171F10R	CR 180/02	10 absolute	157
CR221C10R	CR 250/1	10	276
CR221F10R	CR 250/02	10 absolute	178
CR223C10R	CR 500/1	10	319
CR223F10R	CR 500/02	10 absolute	250

## Filtration - Return



### Return, In Line Filters - Low Pressure – OMT

- Spin on replacement element, by pass set @ 1.7 bar
- Operating pressure - 10 bar.

### OMTI Series – In-Line, Low Pressure - Spin On Element

OMT Model	Donaldson Equiv	Description	Port BSPP	Micron Nominal	Rated Flow lpm
OMTI05ANR	FRCA 60/1	Single Element	3/4"	10	60
OMTI10ANR	FRCA 160/1	Single Element	1 1/4"	10	150
OMTI20ANR-I	FRCA 380/1	Dual Element	1 1/2"	10	300

### Elements

OMT Model	Donaldson Equiv	Micron Nominal	Rated Flow lpm
CS05AN	CA 60/1	10	60
CS05GN	CA 60/02	10 absolute	50
CS06AN		10	120
CS10AN	CA 160/1	10	150
CS10GN	CA 160/02	10 absolute	100
CS15AN		10	220
CS15BN		25	300

### OMTI Series – Indicators

OMT Model	Description
SIM-04/1.25	Pressure indicator 4/1.25 bar
DV130	Differential visual indicator calibrated at 1.3 bar ± 10% (to be mounted only on T20"-I" head)
PE3	Membrane pressure switch with pressure setting 1.3 bar ± 10%

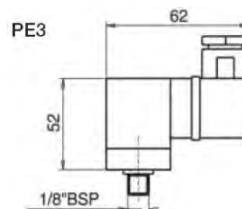

## Filtration – Pressure



### Medium Pressure – In Line – OMT

#### APM Series– In-Line, High Pressure - Cartridge Element

- Steel filters with operating pressures to 110 bar. By-pass set @ 6 bar.

OMT Model	Port	Press. bar	Micron Absolute	Rated Flow lpm
APM37GNR	1/2" BSPP	110	10	60
APM38GNR	1/2" BSPP	110	10	90

#### Elements

OMT Model	To Suit	Micron Absolute	Rated Flow lpm
CPM37GNR	APM37GNR	10	60
CPM38GNR	APM38GNR	10	90

#### APM Series – Indicators

OMT Model	Description
DV500	Visual differential indicator 5 bar
DE500	Electric visual differential indicator/switch 5 bar

DV500

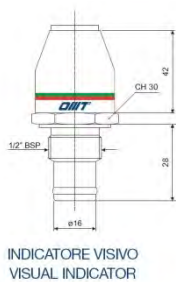

DE500

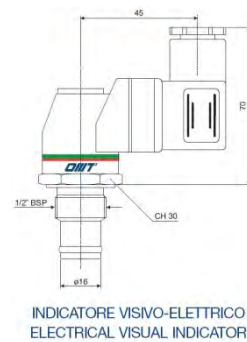



## Filtration – Pressure

### High Pressure – In Line – OMT

#### HPM Series – In-Line, High Pressure - Cartridge Element

- Steel filters with operating pressures to 420 bar. By-pass set @ 6 bar.

OMT Model	Donaldson Equiv	Port	Press. bar	Micron Absolute	Rated Flow lpm
HPM281F10XNR	AP 361.02	1/2" BSPP	420	10	35
HPM421F10XNR	AP 362.02	3/4" BSPP	420	10	80
HPM422F10XNR1	AP 363.02	1" BSPP	420	10	135
HPM622F10XNR12	AP 364.02	1 1/4" SAE	420	3	206

#### Elements

OMT Model	Donaldson Equiv	To Suit	Micron Absolute	Rated Flow lpm
CHP281F06XN	HP 451.52	HPM281F06XNR	6	20
CHP281F10XN	HP 451.52	HPM281F10XNR	10	35
CHP421F06XN	HP 452.52	HPM421F06XNR	6	65
CHP421F10XN	HP 452.52	HPM421F10XNR	10	80
CHP422F06XN	HP 453.52	HPM422F06XNR	6	113
CHP422F10XN	HP 453.52	HPM422F10XNR	10	135
CHP622F03XN	HP 454.52	HPM622F03XNR12	3	206
CHP622F10XN	-	HPM622F10XNR12	10	300
CHP625F06XN	HC9600FKN4H	-	6	-
CHP625F10XN	HC9600FKS4H	-	10	-
CHP626F06XN	HC9600FKN8H	-	6	-
CHP626F10XN	HC9600FKS8H	-	10	-

#### HPM Series – Indicators

OMT Model	Description
DV500	Visual differential indicator 5 bar
DE500	Electric visual differential indicator/switch 5 bar

DV500/800

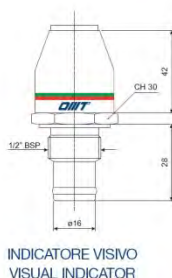

DE500/800

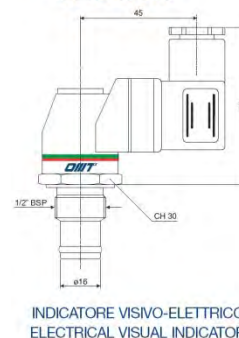

## Filtration – Suction



### Suction Filters – OMT

#### SF Series

- Cast aluminium body with reinforced wire mesh - 90 micron absolute. Recommended flow rates are for **clean** filters.
- Select a filter with a flow greater than maximum operating flow.

OMT Model	Donaldson Equiv	Port BSPP	Dimensions mm	Rated Flow lpm
SF64A-12-GR90	FIOA 35	1/2"	Ø 64 x 109 deep	22
SF64A-34-GR90	FIOA 50	3/4"	Ø 64 x 139 deep	56
SF86A-100-GR90	FIOA 85	1"	Ø 86 x 139 deep	100
SF86B-114-GR90	FIOA 130	1 1/4"	Ø 86 x 139 deep	140
SF150A-112-GR90	FIOA 175	1 1/2"	Ø 150 x 151 deep	200
SF150A-200-GR90	FIOA 230	2"	Ø 150 x 200 deep	340
SF150B-200-GR90	FIOA 360	2"	Ø 150 x 212 deep	400

### Filtration – Accessories

#### Tank Breathers – OMT



- Chrome plated steel breather with galvanised male thread and 10 micron filter element.

OMT Model	Donaldson Equiv	Port BSPP	Dimensions mm
TRM-1-14S1	-	1/4"	Ø 47 x 37.5 high
TRM-1-38S1	FS-6	3/8"	Ø 47 x 37.5 high
TRM-2-12S1	FS-7	1/2"	Ø 75 x 46 high
TRM-2-34S1	-	3/4"	Ø 75 x 46 high
TRM-2-100S1	FS-8	1"	Ø 75 x 46 high

### Filler Breathers – OMT



- 10 micron air filter. Predrilled flanges and gasket supplied.

OMT Model	Donaldson Equiv	Type	Cap Diameter mm	Overall Length mm
TR-1S1	TCO 300	No basket	47	101
TR-2S1E	TCO 500	Extractable basket	75	149
TRV3-035S1	TCO 500V	0.35 bar press relief extractable basket	75	197
TRC-3S1	-	Lockable with extractable basket	75	204





## Filtration – Accessories

### Breather Adaptor – OMT

- Raking adaptor for fillers - An aluminium adaptor to enable mounting of TR-2 & TR-3 Series breathers on vertical or sloping surfaces such as the side of a tank, it is fully equipped with screws and gasket in flexoid.

OMT Model
PT-M5

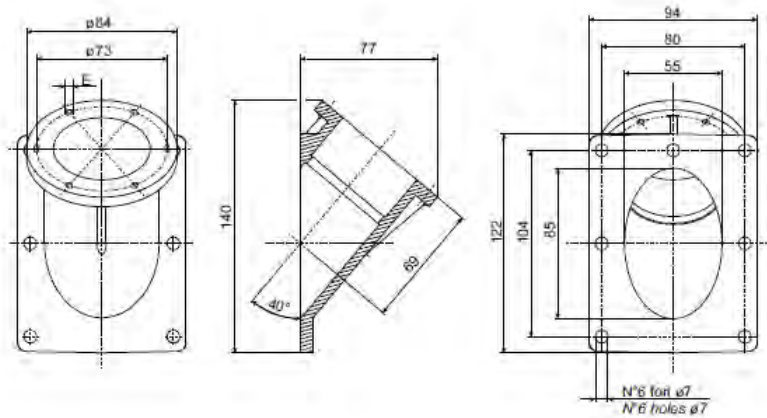

### T.R.A.P. Breathers - Donaldson

- Donaldson's Thermally Reactive Advanced Protection (T.R.A.P.) breathers strip moisture vapor from intake air and exhale the moisture back to the atmosphere on the outflow cycle.

Model	Description
P566174	Mini TRAP breather, 9/16" UNF, airflow up to 85 l/min
P564669	TRAP breather, 1" NPT, airflow up to 1274 l/min, electronic indicator
P565616	TRAP breather, bayonet connection, airflow up to 1274 l/min

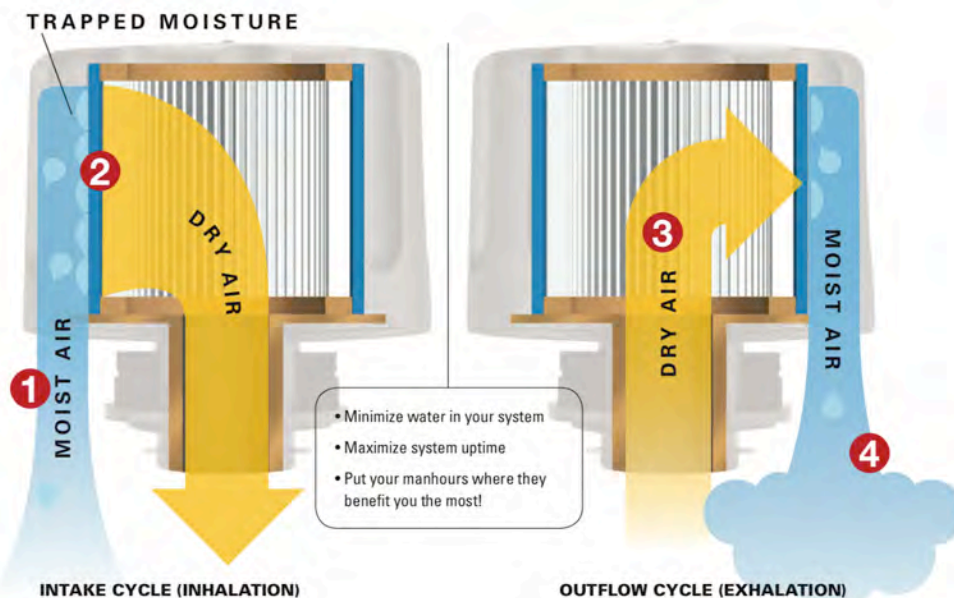

## Contents Section H – Hydraulic Accessories

### H1 Oil Coolers

H1	Air-Oil Coolers	<i>Emmegi</i>
H2	Offline Air-Oil Cooling	<i>Emmegi</i>
H2	Water-Oil Coolers	<i>Emmegi</i>
H3	E-Series Plate Water-Oil Coolers	<i>ASA</i>

### H4 Accumulators

H4	Bladder Accumulators	<i>EPE</i>
H5	Diaphragm Accumulators	<i>EPE</i>

### H6 Indicators / Gauges / Switches / Sensors / Fittings

H6	Filter Gauges	<i>OMT</i>
H7	Sight Level Gauges	<i>Stauff</i>
H7	Electric Level Gauges	<i>Stauff</i>
H7	Pressure Gauges	<i>Wika / Hyspecs</i>
H8	Pressure / Temperature Sensors	<i>IFM</i>
H8	Pressure / Temperature Sensors	<i>Hydraforce</i>
H9	Wireless Bluetooth Pressure Transducer	<i>Transducers Direct</i>
H10	Test Points & Hoses	<i>Stauff</i>
H10	SAE Flanges	<i>OMT</i>
H11	SAE Suction Flanges	<i>ASA</i>

### H12 Hydraulic Test Equipment

H12	Diagnostic Test Equipment	<i>Webtec</i>
-----	---------------------------	---------------

## Oil Coolers - Air - Emmegi



**For cooling hydraulic and other fluids on continuous and heavy-duty mobile applications.**

- Features:**
- Fluid to be cooled: - Compatible with aluminium
  - Max. oil viscosity: - 10 – 100 cST
  - Working pressure: - Up to 20 bar
  - Air flow: - Suction
  - Low pressure drops
- Material:**
- Main cooler body; aluminium - Fan; steel or hard plastic - Fan protection; steel or hard plastic
  - Included in kit 50°C - 60°C thermostat and mounting hardware.
  - Consult Hyspecs for IP ratings when intending to use in dusty or wet environments.

Code	Model	Description
2W2012301	MG-AIR-2020KBV-12V	12 VDC, 0.12kW, 3100 rpm, noise level - 67 dBa, 190 lpm
2W2024301	MG-AIR-2020KBV-24V	24 VDC, 0.12kW, 3000 rpm, noise level - 67 dBa, 190 lpm
2W2001301	MG-AIR-2020KBV-230	230 VAC - single phase, 0.055kW, 2650 rpm, 190 lpm
2W2003301	MG-AIR-2020KBV-400	230/400 VAC - 3 phase, 0.045kW, 2850 rpm, 190 lpm
2W2056301	MG-AIR-2020KBV-56	Gr.2 hydraulic motor (not included), 2500 rpm, 190 lpm
2W2412301	MG-AIR-2024KBV-12V	12 VDC, 0.12kW, 3000 rpm, noise level - 67 dBa, 190 lpm
2W2424301	MG-AIR-2024KBV-24V	24 VDC, 0.12kW, 3000 rpm, noise level - 67 dBa, 190 lpm
2W2401301	MG-AIR-2024KBV-230	230 VAC - single phase, 0.135kW, 2500 rpm, 190 lpm
2W2403301	MG-AIR-2024KBV-400	230/400 VAC - 3 phase, 0.120kW, 2670 rpm, 190 lpm
2W2456301	MG-AIR-2024KBV-56	Gr.2 hydraulic motor (not included), 2500 rpm, 190 lpm
2W4012301	MG-AIR-2040KBV-12V	12 VDC, 0.12kW, 2500 rpm, noise level - 73 dBa, 246 lpm
2W4024301	MG-AIR-2040KBV-24V	24 VDC, 0.12kW, 2500 rpm, noise level - 73 dBa, 246 lpm
2W4001301	MG-AIR-2040KBV-230	230 VAC - single phase, 0.320kW, 1260 rpm, 246 lpm
2W4003301	MG-AIR-2040KBV-400	230/400 VAC - 3 phase, 0.290kW, 1245 rpm, 246 lpm
2W4056301	MG-AIR-2040KBV-56	Gr.2 hydraulic motor (not included), 2500 rpm, 246 lpm

### Spare Components

Code	Description
0648610000000	Cooler body only, 2020KBV bypass, 190 lpm
0679550000000	Cooler body only, 2024KBV bypass, 190 lpm
0684700000000	Cooler body only, 2040KBV bypass, 246 lpm
TM 44/A1	Fixed Thermostat 40 -28 °C
TM 45/A1	Fixed Thermostat 50 -38 °C
TM 46/A1	Fixed Thermostat 60 -48 °C
0345140	12 VDC Suction Fan/Motor, 2015/2020
0345150	12 VDC Blowing Fan/Motor, 2015/2020
0345160	24 VDC Suction Fan/Motor, 2015/2020
0345180	12 VDC Suction Fan/Motor, 2024
0345200	24 VDC Suction Fan/Motor, 2024
0345260	12 VDC Suction Fan/Motor, 2040
0345280	24 VDC Suction Fan/Motor, 2040
0345290	24 VDC Blowing Fan/Motor, 2040
BF2Z15	Spline sleeve to suit group 2 hydraulic motor



## Oil Coolers - Air - Offline Cooling Unit - Emmegi

Off-line for cooling unit for hydraulic and other fluids on continuous and heavy-duty mobile applications.

<b>Features</b>	-Fluid to be cooled:	- Compatible with aluminium
	-Max. oil viscosity:	- 20 - 320cst
	-Working pressure:	- 6 bar
	-Air flow:	- Blowing
	-Low noise screw pump	
	-SE225 Rated to 40lpm. Other sizes available on request.	
	-IP55 rated	
<b>Material</b>	-Main cooler body: Aluminium, Unit cover, steel.	

Code	Description
SE225CC400B02	Emmegi Cooling Unit Silent 25 Evo Without Filter

## Oil Coolers - Water - Emmegi

- For dissipating thermal energy in installations with hydraulic oil and other compatible fluids.
- The maximum working pressure permissible on the circuit is 12 bar. Heat dissipation is in 1, 2 or 4 passes.
- Note: Corrosive water requires the **salt water** version to be used with a fitted **sacrificial anode**.



Model	Description
MG-54-255-1-SW	Sea water, 1-way circuit, 50 lpm, Ø 54 mm, 1" BSP water inlet, 3/8" BSP oil inlet, 255mm oil port centres
MG-81-310-1-SW	Sea water, 1-way circuit, 120 lpm, Ø 80 mm, 1 1/2" BSP water inlet, 1 1/2" BSP oil inlet, 310mm oil port centres
MG-81-560-1-SW	Sea water, 1-way circuit, 150 lpm, Ø 80 mm, 1 1/2" BSP water inlet, 1 1/2" BSP oil inlet, 560mm oil port centres
MG-81-715-1-SW	Sea water, 1-way circuit, 180 lpm, Ø 80 mm, 1 1/4" BSP water inlet, 1 1/2" BSP oil inlet, 715mm oil port centres
MG-131-285-1-SW	Sea water, 1-way circuit, 140 lpm, Ø 130 mm, 1 1/4" BSP water inlet, 1 1/2" BSP oil inlet, 285mm oil port centres
MG-131-521-1-SW	Sea water, 1-way circuit, 280 lpm, Ø 130 mm, 1 1/4" BSP water inlet, 2" BSP oil inlet, 521mm oil port centres
MG-131-831-2-SW	Sea water, 1-way circuit, 400 lpm, Ø 130 mm, 1 1/4" BSP water inlet, 2" BSP oil inlet, 831mm oil port centres

- Other models and heat dissipation curves available on request.

## Oil Coolers - Water - asa



### E-Series Brazed Plate Heat Exchangers (Indent Only)

The asa E plate heat exchanger is designed for both cooling and heating applications. It is commonly used to cool hydraulic fluid and lubricating oil and can be used for water, air, steam and gas applications.

The benefits of asa E plate heat exchangers are:

- strength
- safety
- downsizing
- high thermal efficiency
- low maintenance
- no gaskets – no leaks

Material – all plates and connectors stainless steel; solder copper

Pressure – Test pressure 43 bar, working pressure 30 bar

### Design

The asa E plate heat exchanger is designed for maximum heat transfer using profiled plates of acid proof stainless steel. The plates form channels through which oil and water pass (alternating every other channel). At the front and back side of the plate package there are cover plates. The cooler plates are brazed together at all outer and inner points of contact. The cooler can be installed in charge-pump circuits as well as in return lines with high pressure variations.

### Performance

The shown performance data is with an oil/water ratio of 2:1 with hydraulic oil ISO VG32 at an oil inlet temperature of 60°C and a water inlet of 20°C.

Code	Description
ILWPL10014EK	Fresh water, 48 l/min, 9 kW cooling, ½" BSP ports, 1.8 kg
ILWPL20020EK	Fresh water, 62 l/min, 12 kW cooling, ¾" BSP ports, 2.3 kg
ILWPL22030EK	Fresh water, 103 l/min, 32 kW cooling, 1" and 1½" BSP ports, 6.1 kg
ILWPL53020EK	Fresh water, 92 l/min, 37 kW cooling, 1" BSP ports, 8.8 kg
ILWPL40050EK	Fresh water, 210 l/min, 65 kW cooling, 1" BSP ports, 10.2 kg
ILWPL53040EK	Fresh water, 180 l/min, 70 kW cooling, 1" BSP ports, 13.1 kg
ILWPL53060EK	Fresh water, 220 l/min, 98 kW cooling, 1" BSP ports, 18.4 kg
ILWPL70060EK	Fresh water, 500 l/min, 235 kW cooling, 1½" BSP ports, 39.9 kg





## Accumulators - EPE

### Bladder Accumulators

- Certified to AS1210 pressure vessel requirements. • Accumulators offer solutions to fluid control problems. • *Auxiliary power source/energy conservation* - Reduces the need for large pumping capacity by supplementing the output of the pump beyond its capacity during peak periods.
- *Leakage compensators* - Reduces the need for frequent pump operation by compensating for internal or external leakage when the system is pressurised but not in operation for prolonged periods.
- *Thermal expansion compensators* - Prevents damage to circuit components and piping in a closed loop system when temperature variations cause expansion or contraction to the fluid volume by taking up any change in volume.
- *Emergency power source* - Makes the hydraulic system failsafe in the event of pump or electric motor failure by actuating or retracting a cylinder to a safe position hereby preventing damage or injury.
- *Fluid make-up device* - In a closed loop system, it is necessary to provide a source of fluid to make-up the difference in fluid volume between the rod end and the blind end of a cylinder.
- *Hydraulic shock absorber* - By absorbing the shock in a system preventing pipe line failure, loosened fittings, and damaged components.
- *Holding device* - Saves power, reduces pump wear, prevents oil overheating by maintaining high pressure in a cylinder for long periods of time allowing the pump to be unloaded or shut down.

Model	Description	Mean Flow lpm	Max.Press bar
AS0.2P360CG4V-0	0.2 Litre, 1/2" BSPP	70	330
AS0.7P360CA5V-0	0.7 Litre, 3/4" BSPP	150	360
AS1P315CA5V-2	1.0 Litre, 3/4" BSPP	150	315
AS1.5P360CA5V-8	1.5 Litre, 3/4" BSPP	150	315
AS3P315CA7V-2	3.0 Litre, 1 1/4" BSPP	300	315
AS5P260CA7V-2	5.0 Litre, 1 1/4" BSPP	300	260
AS10P360CA9V-2	10.0 Litre, 2" BSPP	500	240
AS15P240CA9V-2	15.0 Litre, 2" BSPP	500	240
AS20P360CA9V-2	20.0 Litre, 2" BSPP	500	240
AS35P240CA9V-2	35.0 Litre, 2" BSPP	500	240
AS55P240CA9V-2	55.0 Litre, 2" BSPP	500	240

### Spare Components

Model	Description
S0.2P-C50V	0.2 Litre Bladder Kit
S0.7P-C50V	0.7 Litre Bladder Kit
S1P-C50V	1.0 Litre Bladder Kit
S2.5P-C50V	1.5 Litre Bladder Kit
S3P-C50V	3.0 Litre Bladder Kit
S5P-C50V	5.0 Litre Bladder Kit
S10P-C50V	10.0 Litre Bladder Kit
S15P-C50V	15.0 Litre Bladder Kit
S20P-C50V	20.0 Litre Bladder Kit
S55P-C50V	55.0 Litre Bladder Kit
A/HS7930P16DES	Standard safety block solenoid unloader cavity plugged
A/HS7930P16DES	Standard safety block with solenoid unloader
Connection Adaptor	1 1/4" or 2" BSPP
Lock out kit	Safety lock out kit
C115-CP	Clamp for AS1- 3.0 litre bladder accumulators
C170-CP	Clamp for AS5 litre bladder accumulator
C220-CP	Clamp for AS10-55 litre bladder accumulators

## Accumulators - EPE



### Spare Components

Model	Description
MM0.35-P	0.35 Litre Diaphragm Kit
MM0.5-P	0.50 Litre Diaphragm Kit
MM0.75-P	0.75 Litre Diaphragm Kit
MM1.5-P	1.50 Litre Diaphragm Kit
MM2.5-P	2.50 Litre Diaphragm Kit
KG2087-P	EPE Seal kit for diaphragm AM1.5 & AM 2.5
PC250S4	Accumulator charge kit, includes charging valve, pressure gauge and gas hose, 5/8" UNF
PC250S1	Charge kit, includes charging valve, pressure gauge and gas hose, 5/8" UNF-W21.7x14
PCM250M4	Accumulator charge kit, includes charging valve, pressure gauge and gas hose, M28 x 1.5

### Diaphragm Accumulators – Welded

Model	Description	Max. Press bar
AMS0.16P210CG4VM-0	0.16 Litre 1/2" BSP female	250
AMS0.32P210CG4VM-0	0.32 Litre 1/2" BSP female	210
AMS0.5P210CG4VM-0	0.5 Litre 1/2" BSP female	210
AMS0.75P210CG4VM-0	0.75 Litre 1/2" BSP female	210
AMS1P210CG4VM-2	1 Litre 1/2" BSP female	210
AMS1.4P210CG4VM-2	1.4 Litre 1/2" BSP female	210
AMS2P210CG4VM-2	2 Litre 1/2" BSP female	210



## Indicators / Gauges / Switches / Sensors / Fittings

### Filter Gauges - OMT

#### OMTI Series – Indicators

OMT Model	Description
SIM-04/1.25	Pressure indicator 4/1.25 bar
DV130	Differential visual indicator calibrated at 1.3 bar ± 10% (Mounted only on T20"-1" head)
PE3	Membrane pressure switch with pressure setting 1.3 bar ± 10%

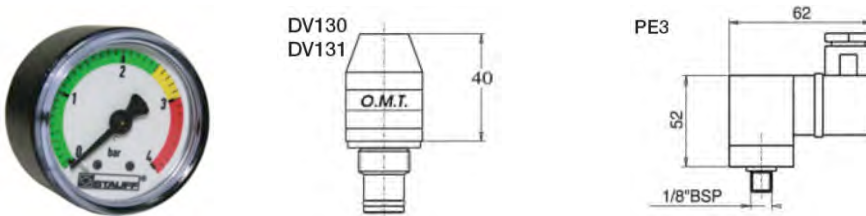

#### HPM Series – Indicators

OMT Model	Description
DV500	Visual differential indicator 5 bar
DE500	Electric visual differential indicator/switch 5 bar

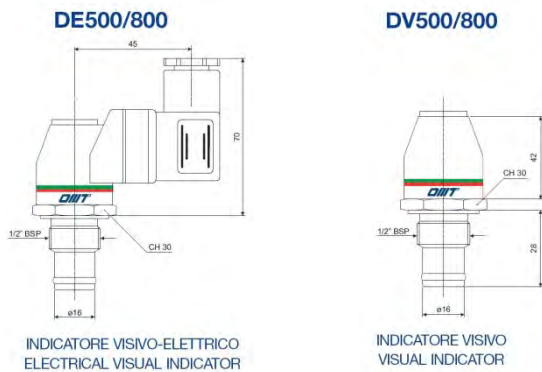

## Indicators / Gauges / Switches / Sensors / Fittings

### Sight Level/Temp Gauges – Stauff

- Visual fluid level and temperature indication in hydraulic reservoirs with maximum tank pressures not exceeding 2 bar.
- Operating temperature -30°C to 80°C, IP65 rating.



Model	Description
SNA076B-S-T-10	76 mm bolt centres, level and temperature, 10 mm bolts
SNA076B-S-T-12	76 mm bolt centres, level and temperature, 12 mm bolts
SNA127B-S-T-12	127 mm bolt centres, level and temperature, 12 mm bolts
SNA254B-S-T-12	254 mm bolt centres, level and temperature, 12 mm bolts
SNA305B-S-T-12	305 mm bolt centres, level and temperature, 12 mm bolts
SG-24	1½" BSP button type level indicator only

### Electric Level Gauges - Stauff

- Visual / electrical fluid level indication in hydraulic reservoirs with maximum tank pressures not exceeding 1bar.
- Magnetic float activates switch when fluid level drops below contact level within 60 mm of lower banjo bolt.
- Make contact / normally open (normally closed available on request).
- Operating temperature -30°C to 80°C, IP65 rating.
- Switching voltage: max. 50 V AC/DC, switching current: max. 0.25 A



Model	Description
SNK127V-C-O-10-R	127 mm bolt centres, vis/electric level indicator, 10 mm bolts
SNK127V-C-O-12-R	127 mm bolt centres, vis/electric level indicator, 12 mm bolts
SNK254V-C-O-12-R	254 mm bolt centres, vis/electric level indicator, 12 mm bolts
SNK305V-C-O-12-R	305 mm bolt centres, vis/electric level indicator, 12 mm bolts
TS-SNA/SNK-0-70	Temp switch, normally open, replaces 12mm lower bolt. Switches at 70°C.

### Pressure Gauges – Ø 63mm Stainless Steel, Brass Internals, ¼" BSPP Wika/Hyspecs



Model	Port Location	Max. Press. bar
WG7090	Bottom entry	10
IW21238	Bottom entry	40
WG7140	Rear entry	40
WG7160	Bottom entry	100
WG7165	Rear entry	100
IW20979	Rear entry	207
IW20723	Bottom entry	250
IW20722	Rear entry	250
IW21076	Bottom entry	400
IW21171	Rear entry	400
WG7250	Bottom entry	700
WG7255	Rear entry	700
WG6999	Gauge panel bracket	
WG6997	Pressure gauge panel flange	

## Indicators / Gauges / Switches / Sensors / Fittings



### Pressure / Temperature Sensors – IFM

- Manufactured in Germany these sensors all feature ¼” BSPP male threads with seal. Electrical connection is the M12 industrial standard. For customers who are not using their own M12 wiring loom we stock a 90 degree wireable socket.

Model	Description
PK6523	Pressure switch, 0-25 bar, normally open or closed switch
PK6521	Pressure switch, 13-250 bar, normally open or closed switch
PK6520	Pressure switch, 20-400 bar, normally open or closed switch
PT5401	Pressure Transducer, 0-250 bar, 4...20mA analogue output
PT5400	Pressure Transducer, 0-400 bar, 4...20mA analogue output
TK6110	Temperature switch 16-140 degrees Celsius, intuitive switch point setting
E11509	M12 Wireable socket 90 degrees
E30094	Protective cover
EVC004	Cable M12, 2 metres
EVC005	Cable M12, 5 metres
DX2042	Multifunction display for monitoring analogue standard signals

### Pressure / Temperature Sensors – Hydraforce

- Accurate sensors designed for off-road applications.
- These temperature sensors are thermistor style with padded resistors.
- Pressure sensors have 1% total error band accuracy and are IP67 rated.



Part	Description
4000655	Hydraforce pressure sensor ERP035 (35 bar)
4000659	Hydraforce pressure sensor ERP414 (414 bar)
4001952	Connector kit DT04-3
4206200	Hydraforce Thermistor temperature sensor ERT120 (-40°C - 150°C)
4001970	Connector kit DT06-2

Hyspecs has other electronic & radio-remote control options available. We also offer full consultation, design, program, installation, and commissioning services for your project. Please contact Hyspecs to discuss your project, or other options not shown above.

## Indicators / Gauges / Switches / Sensors / Fittings

### Wireless Bluetooth Pressure Transducer – Transducers Direct

- Take advantage of remote pressure transducer monitoring using your smartphone or tablet. Through a wireless Bluetooth pressure transducer - the first of its kind in the world - you can connect wirelessly to tablets and smartphones with Transducer Directs free app and monitor your equipment anywhere you are, 24/7.



Code	Model	Description	Pressure range bar
TD8473	TDWLB3000134	Wireless pressure transducer ¼" BSPP	0-207
TD8575	TDWLB5000134	Wireless pressure transducer ¼" BSPP	0-345
TD8427	TDWLB010K134	Wireless pressure transducer ¼" BSPP	0-690
TD8488	TDWLB010K132	Wireless Pressure transducer, ¼" BSPP, 0.25%	0-690
TD8489	TDWLB-DL5000132	Wireless Pressure transducer, ¼" BSPP, 0.25% with data logging	0-345
TD7919	TDWLB-BAT3	Replacement battery pack	

#### Features & Benefits

- Latest generation 2 technology for reliability and longer battery life
- Data logging capable with onboard memory - monitor the pressure continuously and come back to it after a period of time to check the readings
- Download the free app, install the transducer and wirelessly connect - no confusing wiring to figure out
- Connects to smart phones, tablets, PCs with BLE (Bluetooth® Low Energy)
- Certified Bluetooth® Wireless technology
- Pressure ranges from Vacuum to 690 bar
- Long battery life (proprietary technology)
- 1% Standard accuracy with optional 0.25% Ultra high accuracy
- Stainless Steel high impact polycarbonate construction
- Alarm set points
- Secure field programmable naming
- Operating temperatures -10°C to 85°C
- Schrader, NPT, SAE and G 1/4 pressure connection

#### TDWLB APP

Free download from Apple iTunes or Google Play. Search "TDWLB".



## Indicators / Gauges / Switches / Sensors / Fittings



### TEST POINTS AND HOSES – STAUFF

Model	Description	Pressure <i>bar</i>
SMS20M1/4-300B-1	Stauff test hose 300 mm	630
SMS20M1/4-600B-1	Stauff test hose 600 mm	630
SMS20M1/4-1000B-1	Stauff test hose 1000 mm	630
SMS20M1/4-1500B-1	Stauff test hose 1500 mm	630
SMS20M1/4-2000B-1	Stauff test hose 2000 mm	630
SMS20-500B-1	Stauff test to test hose 500 mm	630
SMS20-1000B-1	Stauff test to test hose 1000 mm	630
SMS20-2000B-1	Stauff test to test hose 2000 mm	630
SMS20-3000B-1	Stauff test to test hose 3000 mm	630
SMK20G1/4PC	Stauff 1/4" BSPP Test Point	630
SMK20G3/8PC	Stauff 3/8" BSPP Test Point	630
SMK207/16UNFPE	Stauff 7/16"-20 Test Point	630
SMK209/16UNFPE	Stauff 9/16"-20 Test Point	630
SMA20G1/4P-OR	1/4" BSP Gauge to hose adaptor	630

### SAE Flanges – OMT



#### BSP Threaded SAE Flanges

Model	Description	Max. Pressure <i>bar</i>
F100G034-M	Code 61 – 3/4" BSPP	345
F102G100-M	Code 61 – 1" BSPP	345
F104G114-M	Code 61 – 1 1/4" BSPP	275
F106G112-M	Code 61 – 1 1/2" BSPP	200
F108G200-M	Code 61 – 2" BSPP	200
F110G212-M	Code 61 – 2 1/2" BSPP	170
F112G300-M	Code 61 – 3" BSPP	135

Model	Description	Max. Pressure <i>bar</i>
F401G012-M	Code 62 – 1/2" BSPP	420
F402G034-M	Code 62 – 3/4" BSPP	420
F403G100-M	Code 62 – 1" BSPP	420
F404G114-M	Code 62 – 1 1/4" BSPP	420

## Indicators / Gauges / Switches / Sensors / Fittings

### SAE Flanges OMT cont.



#### Blind SAE Flanges

Model	Description	Working Pressure <i>bar</i>
C401012-M	SAE Code 62 ½" blind	420
C402034-M	SAE Code 62 ¾" blind	420
C403100-M	SAE Code 62 1" blind	420
C404114-M	SAE Code 62 1¼" blind	420
C405112-M	SAE Code 62 1½" blind	420

### SAE Suction Flanges – ASA



The suction unit (pump side) is screwed to the adaptor flange, which is welded to the tank.

Model	Description
SDKSS040	Rubber compensator 1½"
SDKSS050	Rubber compensator 2"
SDKSS063	Rubber compensator 2½"
SDKSS080	Rubber compensator 3"
SDKSS100	Rubber compensator 4"
SDA00050W	Suction butterfly valve 1½"
SDA00050W	Suction butterfly valve 2"
SDA00063W	Suction butterfly valve 2½"
SDA00080W	Suction butterfly valve 3"
SDA000100W	Suction butterfly valve 4"
SDAET063	Weld adaptor flange 2" and 2½"
SDAET080	Weld adaptor flange 3"
EAFSM	Mechanical limit switch
EAFSI	Inductive limit switch
SDAERASTBE	Locking pin



## Hydraulic Test Equipment

### Webtec Hydraulic Test Equipment

Webtec are specialist manufacturers of hydraulic measurement and control products helping to improve the productivity of heavy machinery.

For anyone who has experienced a hydraulic component failure when they could least afford it, the Webtec range of test equipment holds the answer.

If your system is down and oil is collecting around your feet, the downtime is costing you money. You need to quickly identify which component has failed, fix it, test the system and get back to work.

A Webtec portable tester will allow you, even if you are working alone, to easily and safely simulate operating conditions using the built-in load valve to help pinpoint the fault.

**Hyspecs carry a wide range of Webtec products, the following are but a few examples of this range. Please speak to a Hyspecs Engineer to find out more.**

### Diagnostic Test Equipment

Ideal for hydraulic fault-finding and reporting, used by mobile machinery dealers & service technicians worldwide. The equipment often pays for itself the second time it's used through a reduction in 'warranty claims', only replacing faulty parts and a reduction in machine downtime.

### Digital Testers With or Without Remote Inputs

- Measure flow (1% FS), pressure and temperature
- Simple 'On / Off' control
- Secondary flow and speed inputs
- Simulate machine performance using loading valve
- INTERPASS(R) protected



### Flow Meters

- Precision turbine flow meters (1% IR)
- 2 models cover range 0.1 - 750 lpm, up to 480 bar
- Additional top ports
- With or without built-in loading valve





## Hydraulic Test Equipment

### Flow Indicators

- Unidirectional, up to 400 lpm and 420 bar
- Optional relay switch
- Optional thermometer
- Available in aluminium for oil, or brass for water
- Ideal for tank line monitoring



### Digital Pressure Gauge

- Digital pressure gauge with peak capture
- Two pressure ranges available 100 / 600 bar
- Backlit display
- Change engineering units

For further information please call us on 1800 497 732 and talk with a sales engineer or email [hyspecs@hyspecs.com.au](mailto:hyspecs@hyspecs.com.au).



## Contents Section I – Drive Accessories

<b>I1</b>	<b>Planetary Drives</b>	
I1	Comer PG Series Introduction	<i>Comer</i>
I2	PG 100 Series	<i>Comer</i>
I3	PG 160 Series	<i>Comer</i>
I4	PG 250 Series	<i>Comer</i>
I5	PG 500 Series	<i>Comer</i>
I6	PG 700 Series	<i>Comer</i>
I7	PG 1000 Series	<i>Comer</i>
I8	PG 1600 Series	<i>Comer</i>
I9	PG 1800 Series	<i>Comer</i>
I10	PG 2500 Series	<i>Comer</i>
I11	Fairfield Shaft Type Series	<i>Fairfield</i>
<b>I12</b>	<b>P.T.O Gear Boxes</b>	
I12	ML Series	<i>Koreson</i>
<b>I13</b>	<b>Electromagnetic Clutches</b>	
I13	IE Series	<i>Koreson</i>
<b>I13</b>	<b>Over-hung Load Adaptors</b>	
I13	SU Series	<i>Koreson</i>
<b>I14</b>	<b>Failsafe Brakes</b>	
I14	Failsafe Type	<i>Ausco</i>
I14	Failsafe Type	<i>MICO</i>
<b>I15</b>	<b>Spline Billets &amp; Shafts</b>	
I15	Hubs	<i>Hub City</i>
I15	Shafts	<i>Hub City</i>
I15	Reducing Bushes	<i>Hub City</i>
<b>I16</b>	<b>Flexible Couplings / Bell Housings / Damping</b>	
I16	ND Aluminium Series	<i>OMT</i>
I16	POL Steel Series	<i>OMT</i>
I17	Bell Housings	<i>OMT</i>
I18	Bell Housings/Couplings for Petrol Engines	<i>OMT</i>
I18	Bell Housing Adaptor GC Pump	<i>Hyspecs</i>
I18	Damping Rings for Power Packs	<i>OMT</i>
I19	Damping Rods for Foot Flange Motors	<i>OMT</i>
I19	Foot Flanges	<i>OMT</i>

## Planetary Drives – Comer Industries PG Series Introduction

- Compact modular gearbox, fully reversible, final drive system built specifically for high torque, low speed Geroter/ Geroler motors. Piston and gear motors with SAE mountings can be used for applications needing high speed and low torque.
- Available in shaft, spindle, shrink disc and wheel outputs.
- Models shown are stocked items. Different mount, shaft and ratio options are available on request. Please contact Hydraulic Specialties.

### Technical Definitions

#### Reduction Ratio $i$

The ratio resulting from input speed  $n^1$  and output speed of the gearbox  $n^2$ .

$$i = \frac{n^1}{n^2}$$

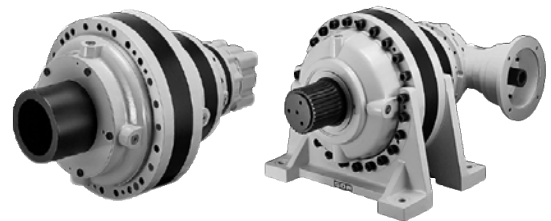

#### Continuous Input Speed $n^1$ cont. (rpm)

Maximum continuous speed permitted.

#### Design Life $n^2 \times h$ (rpm x hours)

The product of the output speed from the gearbox  $n^2$  measured in rpm multiplied by the working life measured in hours  $h$ . From this product an indication of the theoretical number of cycles performed by the gearbox in relation to the expected life of the gearbox can be obtained.

#### Service Factor $f_s$

The coefficient used to calculate the correct selection of gearbox in relation to the severity of application and working conditions to be undertaken.

#### Duration Factor $f_h$

The coefficient used to calculate the correct selection of gearbox in relation to the design life.

#### Actual Torque $M_e$ (Nm)

The average torque absorbed by the gearbox output shaft. A histogram is provided in the catalogue to assist you in calculating the average torque when several torque loads are present.

#### Continuous Torque $M_c$ (Nm) ISO6336

The value of the output torque that can be transmitted continuously by the gearbox calculated according to ISO DP 6336. For each reduction size and ratio, the diagrams indicate the transmitted value in relation to the requested life time  $n^2 \times h$ . Values stated in the diagrams are valid for a Service Factor ( $f_s$ ) of 1.

#### Maximum Or Peak Torque $M_{max}$ (Nm)

The maximum output torque that can be transmitted by the gearbox without causing damage or permanent deformation to the internal components and structure. This value should not be exceeded and must be considered as the maximum instant output torque due to working or start up peaks. It cannot be considered as the continuous working torque.

#### Thermal Rating $P_t$ (kW)

The value of maximum power that the gearbox can transmit continuously with normal splash lubrication, a maximum oil temperature of 90°C, horizontal mounted position, and an ambient temperature of 20°C. For values of higher continuous power or when a cooler operating temperature is desired it is necessary to cool the lubricating oil and circulate it through the gearbox. A cooler and circulating pump can be supplied upon request.

#### Permitted Temperature (°C)

Standard gearboxes are suitable for operation in temperatures between -20°C and +90°C. For temperatures outside the aforementioned range, it is necessary to fit special seals, which can be supplied upon request.

## Planetary Drives – Comer Industries

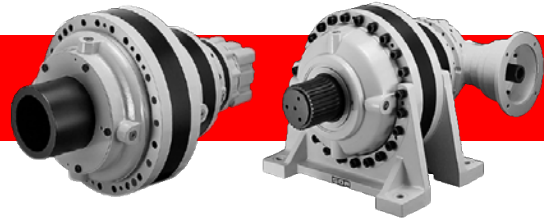

### PG 100 Series

Model	Ratio Range	Max. Cont. Input Speed RPM	Max. Cont. Output Torque* Nm	Thermal Rating kW
PG 101	3.55:1 – 8.67:1	2800	1110	12
PG 102	12.6:1 – 45.5:1	2800	1110	8
PG 103	58.5:1 – 394.8:1	2800	1110	5
PG 104	337.3:1 – 3422.1:1	2800	1110	1.5

\* Max continuous output torque may go up or down dependant on ratios used and service life required.

#### How To Order

**Please Contact Hydraulic Specialties For Pricing**

PG10	<b>1</b> Stages	<b>2</b> Output	<b>Ratio</b>	<b>3</b> Input	<b>4</b> Mount	<b>5</b> Brake	<b>6</b> Bevel
------	--------------------	--------------------	--------------	-------------------	-------------------	-------------------	-------------------

To get the model code add 1 + 2 + 3 + 4 + 5 + 6

e.g. PG101 PC 3.55 SAEA-2B13T H (no brake or bevel)

#### 1. Stages

Stages	Code
1 stage	1
2 stages	2
3 stages	3
4 stages	4

#### 2. Output Adder

Output	Code
Male keyed	PC
Male splined	PS
Foot mount	CPC
Fem. shrink disc	FS
Male keyed	MC
Male splined	MS

#### 3. Input Adder\*

	Code
* When ordering input please specify the female shaft type needed.  e.g. SAEC14T  Splined and worm box input options available – contact Hydraulic Specialties	SAEA-2B
	SAEA-4B
	SAEB
	SAEC
	D71
	D80
	D90
	D100
	D132
	D160
	D180
	EL28
	EL42
	EML42
	EM65

#### 4. Mount Adder

Mount	Code
Horizontal	H
Vertical - Shaft down	V1
Vertical - Shaft up	V2

#### 5. Brake Adder

Model	Code
Light series	RA
Heavy series	RB

#### 6. Bevel Input Adder (Type PGA)

Code & Description
4745.003.000, 2.93:1, male input
4745.002.000, 2.93:1, flange input
4713.500.000, 3.5:1, flange input
4713.501.000, 5.44:1, flange input

Accessories	* For torque arm & shrink disc pricing please contact Hydraulic Specialties.
1703.179.042	Splined Rod KB 100 - 160
1710.100.076	Splined Bushing BS 100 - 160 M-P
1710.102.025	Side Connection Flange FL 100 - 160 M-P
5701.034.000	Stop Bottom Plate FF 100 - 160 M-P

## Planetary Drives – Comer Industries

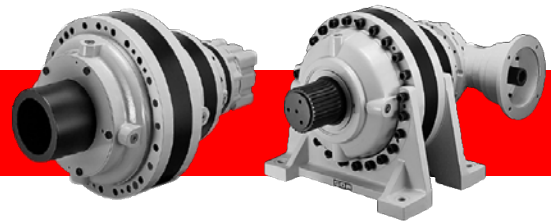

### PG 160 Series

Model	Ratio Range	Max. Cont. Input Speed <i>RPM</i>	Max. Cont. Output Torque* <i>Nm</i>	Thermal Rating <i>kW</i>
PG 161	3.55:1 – 6.75:1	2800	1700	12
PG 162	12.6:1 – 58.5:1	2800	1700	8
PG 163	54.1:1 – 394.8:1	2800	1700	5
PG 164	337.3:1 – 3422.1:1	2800	1700	1.5

\* Max continuous output torque may go up or down dependant on ratios used and service life required.

### How To Order *Please Contact Hydraulic Specialties For Pricing*

PG16	<b>1</b> Stages	<b>2</b> Output	<b>Ratio</b>	<b>3</b> Input	<b>4</b> Mount	<b>5</b> Brake	<b>6</b> Bevel
------	--------------------	--------------------	--------------	-------------------	-------------------	-------------------	-------------------

To get the model code add 1 + 2 + 3 + 4 + 5 + 6  
e.g. PG101 PC 3.55 SAEA-2B13T H (no brake or bevel)

#### 1. Stages

Stages	Code
1 stage	1
2 stages	2
3 stages	3
4 stages	4

#### 3. Input Adder\*

	Code
* When ordering input please specify the female shaft type needed.  e.g. SAEC14T  <i>Splined and worm box input options available – contact Hydraulic Specialties</i>	SAEA-2B
	SAEA-4B
	SAEB
	SAEC
	D71
	D80
	D90
	D100
	D132
	D160
	D180
	EL28
	EL42
	EML42
EM65	

#### 2. Output Adder

Output	Code
Male keyed	PC
Male splined	PS
Foot mount	CPC
Fem. shrink disc	FS
Male keyed	MC
Male splined	MS

#### 4. Mount Adder

Mount	Code
Horizontal	H
Vertical - Shaft down	V1
Vertical - Shaft up	V2

#### 5. Brake Adder

Model	Code
Light series	RA
Heavy series	RB

#### 6. Bevel Input Adder (Type PGA)

Code & Description
4745.003.000, 2.93:1, male input
4745.002.000, 2.93:1, flange input
4713.500.000, 3.5:1, flange input
4713.501.000, 5.44:1, flange input

Accessories	* For torque arm & shrink disc pricing please contact Hydraulic Specialties.
1703.179.042	Splined Rod KB 100 - 160
1710.100.076	Splined Bushing BS 100 - 160 M-P
1710.102.025	Side Connection Flange FL 100 - 160 M-P
5701.034.000	Stop Bottom Plate FF 100 - 160 M-P

## Planetary Drives – Comer Industries

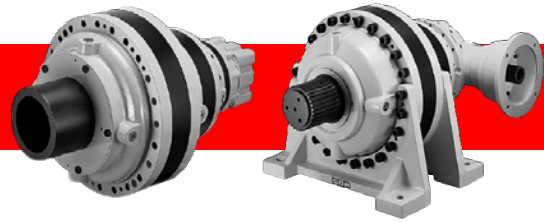

### PG 250 Series

Model	Ratio Range	Max. Cont. Input Speed <i>RPM</i>	Max. Cont. Output Torque* <i>Nm</i>	Thermal Rating <i>kW</i>
PG 251	3.77:1 – 7.25:1	2800	3520	20
PG 252	13.4:1 – 62.8:1	2800	3520	12
PG 253	52.1:1 – 424.1:1	2800	3520	8
PG 254	351.9:1 – 2369.2:1:1	2800	3520	4

\* Max continuous output torque may go up or down dependant on ratios used and service life required.

### How To Order *Please Contact Hydraulic Specialties For Pricing*

PG25	<b>1</b> Stages	<b>2</b> Output	<b>Ratio</b>	<b>3</b> Input	<b>4</b> Mount	<b>5</b> Brake	<b>6</b> Bevel
------	--------------------	--------------------	--------------	-------------------	-------------------	-------------------	-------------------

To get the model code add 1 + 2 + 3 + 4 + 5 + 6  
e.g. PG101 PC 3.55 SAEA-2B13T H (no brake or bevel)

#### 1. Stages

Stages	Code
1 stage	1
2 stages	2
3 stages	3
4 stages	4

#### 2. Output Adder

Output	Code
Male keyed	PC
Male splined	PS
Foot mount	CPC
Fem. shrink disc	FS
Male keyed	MC
Male splined	MS

#### 3. Input Adder\*

	Code
* When ordering input please specify the female shaft type needed.  e.g. SAEC14T  <i>Splined and worm box input options available – contact Hydraulic Specialties</i>	SAEA-2B
	SAEA-4B
	SAEB
	SAEC
	D71
	D80
	D90
	D100
	D132
	D160
	D180
	EL28
	EL42
	EML42
EM65	

#### 4. Mount Adder

Mount	Code
Horizontal	H
Vertical - Shaft down	V1
Vertical - Shaft up	V2

#### 5. Brake Adder

Model	Code
Light series	RA
Heavy series	RB

#### 6. Bevel Input Adder (Type PGA)

Code & Description
4745.003.000, 2.93:1, male input
4745.002.000, 2.93:1, flange input
4713.500.000, 3.5:1, flange input
4713.501.000, 5.44:1, flange input

Accessories	* For torque arm & shrink disc pricing please contact Hydraulic Specialties.
1703.181.042	Splined Rod KB 250 - 500
1712.101.076	Splined Bushing BS 250 - 500 M
1714.101.076	Splined Bushing BS 250 - 500 P
1712.103.025	Side Connection Flange FL 250 - 500 M
1714.103.098	Side Connection Flange FL 250 - 500 P
5701.015.000	Stop Bottom Plate FF 250 - 500 M-P



## Planetary Drives – Comer Industries

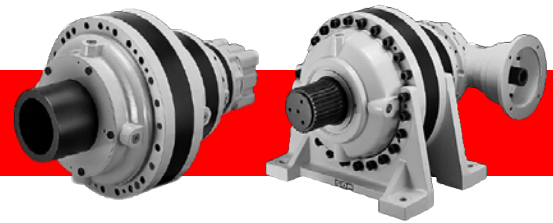

### PG 500 Series

Model	Ratio Range	Max. Cont. Input Speed <i>RPM</i>	Max. Cont. Output Torque* <i>Nm</i>	Thermal Rating <i>kW</i>
PG 501	3.77:1 – 7.25:1	2800	5110	20
PG 502	13.4:1 – 48.9:1	2800	5110	15
PG 503	52.1:1 – 330.3:1	2800	5110	10
PG 504	351.9:1 – 1845.2:1	2800	5110	6

\* Max continuous output torque may go up or down dependant on ratios used and service life required.

**How To Order** *Please Contact Hydraulic Specialties For Pricing*

PG50	<b>1</b>	<b>2</b>	<b>Ratio</b>	<b>3</b>	<b>4</b>	<b>5</b>	<b>6</b>
	Stages	Output		Input	Mount	Brake	Bevel

To get the model code add 1 + 2 + 3 + 4 + 5 + 6

e.g. PG101PC 3.55 SAEA-2B13TH (no brake or bevel)

#### 1. Stages

Stages	Code
1 stage	1
2 stages	2
3 stages	3
4 stages	4

#### 3. Input Adder\*

	Code
* When ordering input please specify the female shaft type needed.  e.g. SAEC14T  Splined and worm box input options available – contact Hydraulic Specialties	SAEA-2B
	SAEA-4B
	SAEB
	SAEC
	D71
	D80
	D90
	D100
	D132
	D160
	D180
	EL28
	EL42
	EML42
EM65	

#### 2. Output Adder

Output	Code
Male keyed	PC
Male splined	PS
Foot mount	CPC
Fem. shrink disc	FS
Male keyed	MC
Male splined	MS

#### 4. Mount Adder

Mount	Code
Horizontal	H
Vertical - Shaft down	V1
Vertical - Shaft up	V2

#### 5. Brake Adder

Model	Code
Light series	RA
Heavy series	RB

#### 6. Bevel Input Adder (Type PGA)

Code & Description
4745.003.000, 2.93:1, male input
4745.002.000, 2.93:1, flange input
4713.500.000, 3.5:1, flange input
4713.501.000, 5.44:1, flange input

#### Accessories

\* For torque arm & shrink disc pricing please contact Hydraulic Specialties.

1703.181.042	Splined Rod KB 250 - 500
1712.101.076	Splined Bushing BS 250 - 500 M
1714.101.076	Splined Bushing BS 250 - 500 P
1712.103.025	Side Connection Flange FL 250 - 500 M
1714.103.098	Side Connection Flange FL 250 - 500 P
5701.015.000	Stop Bottom Plate FF 250 - 500 M-P



## Planetary Drives – Comer Industries

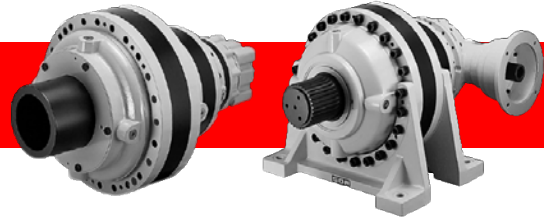

### PG 700 Series

Model	Ratio Range	Max. Cont. Input Speed RPM	Max. Cont. Output Torque* Nm	Thermal Rating kW
PG 701	3.66:1 – 7.00:1	2800	7020	30
PG 702	13.8:1 – 50.7:1	2800	7020	18
PG 703	53.7:1 – 342.5:1	2800	7020	14
PG 704	301.1:1 – 2968.8:1	2800	7020	8

\* Max continuous output torque may go up or down dependant on ratios used and service life required.

**How To Order** *Please Contact Hydraulic Specialties For Pricing*

PG70	1	2		3	4	5	6
	Stages	Output	Ratio	Input	Mount	Brake	Bevel

To get the model code add 1 + 2 + 3 + 4 + 5 + 6  
e.g. PG101 PC 3.55 SAEA-2B13T H (no brake or bevel)

#### 1. Stages

Stages	Code
1 stage	1
2 stages	2
3 stages	3
4 stages	4

#### 3. Input Adder\*

	Code
* When ordering input please specify the female shaft type needed.  e.g. SAEC14T  Splined and worm box input options available – contact Hydraulic Specialties	SAEA-2B
	SAEA-4B
	SAEB
	SAEC
	D71
	D80
	D90
	D100
	D132
	D160
	D180
	EL28
	EL42
	EML42
	EM65

#### 2. Output Adder

Output	Code
Male keyed	PC
Male splined	PS
Foot mount	CPC
Fem. shrink disc	FS
Male keyed	MC
Male splined	MS

#### 4. Mount Adder

Mount	Code
Horizontal	H
Vertical - Shaft down	V1
Vertical - Shaft up	V2

#### 5. Brake Adder

Model	Code
Light series	RA
Heavy series	RB

#### 6. Bevel Input Adder (Type PGA)

Code & Description
4745.003.000, 2.93:1, male input
4745.002.000, 2.93:1, flange input
4713.500.000, 3.5:1, flange input
4713.501.000, 5.44:1, flange input

Accessories	* For torque arm & shrink disc pricing please contact Hydraulic Specialties.
1703.405.042	Splined Rod KB 700
1715.102.076	Splined Bushing BS 700
1715.108.098	Side Connection Flange FL 700
5701.012.000	Stop Bottom Plate FF 700

## Planetary Drives – Comer Industries

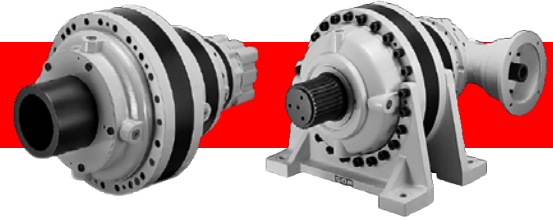

### PG 1000 Series

Model	Ratio Range	Max. Cont. Input Speed RPM	Max. Cont. Output Torque* Nm	Thermal Rating kW
PG 1001	3.55:1 – 8.66:1	2000	12210	40
PG 1002	13.4:1 – 48.9:1	2800	12210	23
PG 1003	57.5:1 – 330.3:1	2800	12210	15
PG 1004	351.9:1 – 2229.7:1	2800	12210	11

\* Max continuous output torque may go up or down dependant on ratios used and service life required.

### How To Order

Please Contact Hydraulic Specialties For Pricing

PG100	1	2	3	4	5	6
	Stages	Output	Input	Mount	Brake	Bevel

To get the model code add 1 + 2 + 3 + 4 + 5 + 6

e.g. PG101 PC 3.55 SAEA-2B13T H (no brake or bevel)

#### 1. Stages

Stages	Code
1 stage	1
2 stages	2
3 stages	3
4 stages	4

#### 2. Output Adder

Output	Code
Male keyed	PC
Male splined	PS
Foot mount	CPC
Fem. shrink disc	FS
Male keyed	MC
Male splined	MS

#### 3. Input Adder\*

	Code
* When ordering input please specify the female shaft type needed.  e.g. SAEC14T  Splined and worm box input options available – contact Hydraulic Specialties	SAEA-2B
	SAEA-4B
	SAEB
	SAEC
	D71
	D80
	D90
	D100
	D132
	D160
	D180
	EL28
	EL42
	EML42
	EM65

#### 4. Mount Adder

Mount	Code
Horizontal	H
Vertical - Shaft down	V1
Vertical - Shaft up	V2

#### 5. Brake Adder

Model	Code
Light series	RA
Heavy series	RB

#### 6. Bevel Input Adder (Type PGA)

Code & Description
4745.003.000, 2.93:1, male input
4745.002.000, 2.93:1, flange input
4713.500.000, 3.5:1, flange input
4713.501.000, 5.44:1, flange input

Accessories	* For torque arm & shrink disc pricing please contact Hydraulic Specialties.
1703.406.042	Splined Rod KB 1000
1716.103.076	Splined Bushing BS 1000
1716.105.098	Side Connection Flange FL 1000
5701.030.000	Stop Bottom Plate FF 1000

## Planetary Drives – Comer Industries

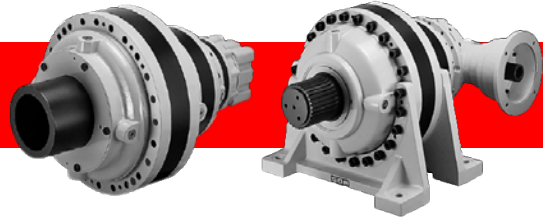

### PG 1600 Series

Model	Ratio Range	Max. Cont. Input Speed RPM	Max. Cont. Output Torque* Nm	Thermal Rating kW
PG 1601	3.55:1 – 6.75:1	2000	18020	40
PG 1602	13.4:1 – 48.9:1	2800	18020	23
PG 1603	57.5:1 – 330.3:1	2800	18020	15
PG 1604	351.9:1 – 2229.7:1	2800	18020	11

\* Max continuous output torque may go up or down dependant on ratios used and service life required.

### How To Order

Please Contact Hydraulic Specialties For Pricing

PG160	1 Stages	2 Output	Ratio	3 Input	4 Mount	5 Brake	6 Bevel

To get the model code add 1 + 2 + 3 + 4 + 5 + 6

e.g. PG101 PC 3.55 SAEA-2B13T H (no brake or bevel)

#### 1. Stages

Stages	Code
1 stage	1
2 stages	2
3 stages	3
4 stages	4

#### 2. Output Adder

Output	Code
Male keyed	PC
Male splined	PS
Foot mount	CPC
Fem. shrink disc	FS
Male keyed	MC
Male splined	MS

#### 3. Input Adder\*

	Code
	SAEA-2B
	SAEA-4B
	SAEB
	SAEC
	D71
	D80
	D90
	D100
	D132
	D160
	D180
	EL28
	EL42
	EML42
	EM65

\* When ordering input please specify the female shaft type needed.  
e.g. SAEC14T

Splined and worm box input options available – contact Hydraulic Specialties

#### 4. Mount Adder

Mount	Code
Horizontal	H
Vertical - Shaft down	V1
Vertical - Shaft up	V2

#### 5. Brake Adder

Model	Code
Light series	RA
Heavy series	RB

#### 6. Bevel Input Adder (Type PGA)

Code & Description
4745.003.000, 2.93:1, male input
4745.002.000, 2.93:1, flange input
4713.500.000, 3.5:1, flange input
4713.501.000, 5.44:1, flange input

Accessories	* For torque arm & shrink disc pricing please contact Hydraulic Specialties.
1703.406.042	Splined Rod KB 1600
1716.103.076	Splined Bushing BS 1600 M
1718.112.041	Splined Bushing BS 1600 P
1716.105.098	Side Connection Flange FL 1600 M
1718.104.098	Side Connection Flange FL 1600 P
5701.030.000	Stop Bottom Plate FF 1600

## Planetary Drives – Comer Industries

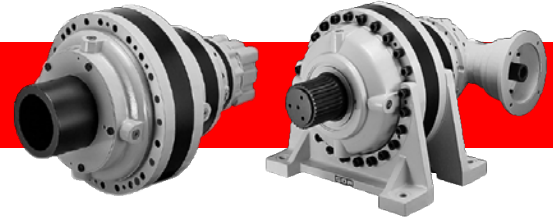

### PG 1800 Series

Model	Ratio Range	Max. Cont. Input Speed <i>RPM</i>	Max. Cont. Output Torque* <i>Nm</i>	Thermal Rating <i>kW</i>
PG 1802	13.0:1 – 30.0:1	2800	18020	25
PG 1803	53.8:1 – 180.2:1	2800	18020	17
PG 1804	348.6:1 – 1216.4:1	2800	18020	13

\* Max continuous output torque may go up or down dependant on ratios used and service life required.

### How To Order

Please Contact Hydraulic Specialties For Pricing

PG180

1  
Stages

2  
Output

Ratio

3  
Input

4  
Mount

5  
Brake

6  
Bevel

To get the model code add 1 + 2 + 3 + 4 + 5 + 6

e.g. PG101 PC 3.55 SAEA-2B13T H (no brake or bevel)

#### 1. Stages

Stages	Code
1 stage	1
2 stages	2
3 stages	3
4 stages	4

#### 3. Input Adder\*

	Code
* When ordering input please specify the female shaft type needed.  e.g. SAEC14T  Splined and worm box input options available – contact Hydraulic Specialties	SAEA-2B
	SAEA-4B
	SAEB
	SAEC
	D71
	D80
	D90
	D100
	D132
	D160
	D180
	EL28
	EL42
	EML42
	EM65

#### 2. Output Adder

Output	Code
Male keyed	PC
Male splined	PS
Foot mount	CPC
Fem. shrink disc	FS
Male keyed	MC
Male splined	MS

#### 4. Mount Adder

Mount	Code
Horizontal	H
Vertical - Shaft down	V1
Vertical - Shaft up	V2

#### 5. Brake Adder

Model	Code
Light series	RA
Heavy series	RB

#### 6. Bevel Input Adder (Type PGA)

Code & Description
4745.003.000, 2.93:1, male input
4745.002.000, 2.93:1, flange input
4713.500.000, 3.5:1, flange input
4713.501.000, 5.44:1, flange input

Accessories	* For torque arm & shrink disc pricing please contact Hydraulic Specialties.
1703.406.042	Splined Rod KB 1800
1716.103.076	Splined Bushing BS 1800 M
1718.112.041	Splined Bushing BS 1800 P
1716.105.098	Side Connection Flange FL 1800 M
1718.104.098	Side Connection Flange FL 1800 P
5701.030.000	Stop Bottom Plate FF 1800

## Planetary Drives – Comer Industries

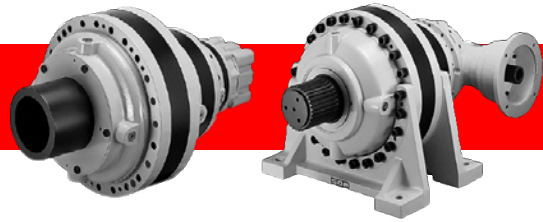

### PG 2500 Series

Model	Ratio Range	Max. Cont. Input Speed RPM	Max. Cont. Output Torque* Nm	Thermal Rating kW
PG 2501	4.00:1 – 6.25:1	1500	30760	50
PG 2502	14.6:1 – 43.7:1	2800	30760	30
PG 2503	55.4:1 – 317.1:1	2800	30760	20
PG 2504	338.7:1 – 1773.9:1	2800	30760	15

\* Max continuous output torque may go up or down dependant on ratios used and service life required.

**How To Order**      *Please Contact Hydraulic Specialties For Pricing*

PG250	1	2	3	4	5	6
	Stages	Output	Ratio	Input	Mount	Brake

To get the model code add 1 + 2 + 3 + 4 + 5 + 6  
e.g. PG101 PC 3.55 SAEA-2B13T H (no brake or bevel)

#### 1. Stages

Stages	Code
1 stage	1
2 stages	2
3 stages	3
4 stages	4

#### 3. Input Adder\*

	Code
* When ordering input please specify the female shaft type needed.  e.g. SAEC14T  Splined and worm box input options available – contact Hydraulic Specialties	SAEA-2B
	SAEA-4B
	SAEB
	SAEC
	D71
	D80
	D90
	D100
	D132
	D160
	D180
	EL28
	EL42
	EML42
EM65	

#### 2. Output Adder

Output	Code
Male keyed	PC
Male splined	PS
Foot mount	CPC
Fem. shrink disc	FS
Male keyed	MC
Male splined	MS

#### 4. Mount Adder

Mount	Code
Horizontal	H
Vertical - Shaft down	V1
Vertical - Shaft up	V2

#### 5. Brake Adder

Model	Code
Light series	RA
Heavy series	RB

#### 6. Bevel Input Adder (Type PGA)

Code & Description
4745.003.000, 2.93:1, male input
4745.002.000, 2.93:1, flange input
4713.500.000, 3.5:1, flange input
4713.501.000, 5.44:1, flange input

Accessories	* For torque arm & shrink disc pricing please contact Hydraulic Specialties.
1703.407.042	Splined Rod KB 2500
1718.112.041	Splined Bushing BS 2500
1718.104.098	Side Connection Flange FL 2500
5701.042.000	Stop Bottom Plate FF 2500

## Planetary Drives – Fairfield

- Compact infinitely variable, fully reversible, final drive system built specifically for high torque, low speed Geroter / Geroler motors. Piston and gear motors with SAE mountings can be used for applications needing high speed and low torque.
- Available in either shaft, spindle or wheel outputs.

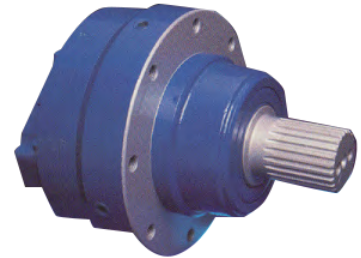

### Shaft Type

Model	Reduct. Ratio	Mount	Input Shaft	Output Shaft	Max. Input Speed RPM	Output Torque. Nm	Cont. Power kW
S07A26604	4.105:1	Mod SAE 'A' 2/4 bolt	1" 6B Spline	1 1/2" Parallel	3000	845	7.5
S1C566S4	4.17:1	Mod SAE 'A' 2/4 bolt	1" 6B Spline	2" Parallel	5000	1690	15
S1C533S4	4.17:1	Mod SAE 'B' 2 bolt	7/8" 13T Spline	2" Parallel	5000	1690	15
S1E1466S4	4.17:1	Mod SAE 'C' 2 bolt	1" 6B Spline	Spindle output	5000	1690	15
S2A42621	20.86:1	Mod SAE 'A' 2/4 bolt	1" 6B Spline	3" Parallel	4000	2817	56



## P.T.O. Gear Boxes - Koreson

- P.T.O. gearboxes provide the connection for a hydraulic pump to a low-speed tractor power take off. The standard P.T.O. speed, 540 rpm, is increased by the gearbox to the optimal speed conditions for the pump. Different input speeds are accepted but the output speed should not exceed 3000 rpm.
- Minimum and maximum temperatures should not exceed -20°C and +80°C.
- Torque data listed is for continuous duty and can be increased by 25% intermittently.
- The oil level must be maintained to the proper level and should be changed after the first 35/50 hours use and thereafter at least every 12 months.



Model	Ratio	Description	Output Torq. Nm
KM6001-5	3.5:1	Group 2, 1 3/8" 6T spline input - male	58
KM6002-5	3.5:1	Group 2, 1 3/8" 6T spline input - female	58
KM7001-5	3.5:1	Group 2/3, 1 3/8" 6T spline input - male	130
KM7002-3	2.5:1	Group 2/3, 1 3/8" 6T spline input - male	180
KM7002-5	3.5:1	Group 2/3, 1 3/8" 6T spline input - female	130
KM7105-5	3.5:1	Group 2/3, 1 3/8" 6T spline input - external female/male	130
KMT7001-5	3.5:1	Group 2/3, 1 3/8" 6T spline input - male, cast iron, heavy duty	180
KMT7002-5	3.5:1	Group 2/3, 1 3/8" 6T spline input - fem, cast iron, heavy duty	180

- Includes spline adaptor

Configuration Options	
10003	Spline sleeve - Group 1, 14 T
10005	Spline sleeve - Group 2, 1 in 8 internal taper to 14 T (BF2)
10007	Spline sleeve - Group 2, 1 in 8 internal taper to 15 T
10012	Spline sleeve - Group 2, 1 in 8 internal taper to 15T (ML52)
10014	Spline sleeve - Group 3, 1 in 8 internal taper to 18T (BF3, ML52)
10026	Spline sleeve - Group 2, 14T, 4mm keyway
35505	Spline sleeve - 13T/18T (BF3/13)
60100	600 series PTO gearbox adaptor SAE-A Group 2
96100	700 series PTO gearbox adaptor SAE-A Group 2
96101	700 series PTO gearbox adaptor SAE-B Group 3



## Electromagnetic Clutches - Koreson



- An electromagnetic clutch is a unit designed to convey movement to a hydraulic pump through an electrically controlled on/off pulley.

Model	Voltage VDC	Description	Output Torque Nm
KRS30901	12	Group 1/2 pump mount	100
KRS30903	24	Group 1/2 pump mount	100

- **NOTE:** Spline sleeves listed below are required in addition to clutch and pump combination.

Configuration Options	
10003	Spline sleeve - Group 1, 14 T
10005	Spline sleeve - Group 2, 1 in 8 internal taper to 14 T (BF2)

## Over-Hung Load Adapters - Koreson

- These are suited to drive hydraulic pumps by belts, gears, chains and other transmissions in which heavy radial loads take place. They are directly flanged to the pump and connected by a splined coupling.
- Lifetime is 3500 hours at 1500 rpm.



Model	Description
KS25601	Group 1 pump, 18 mm parallel output shaft.
KS25603	Group 2 pump, 22 mm parallel output shaft.
KS25604-6	Group 3 pump, 24 mm parallel output shaft.

- **NOTE:** Spline sleeves listed below are required in addition to adaptor and pump combination.

Configuration Options	
10003	Spline sleeve - Group 1, 14 T
10005	Spline sleeve - Group 2, 1 in 8 internal taper to 14 T (BF2)
10007	Spline sleeve - Group 2, 1 in 8 internal taper to 15 T
10012	Spline sleeve - Group 2, 1 in 8 internal taper to 15T (ML52)
10014	Spline sleeve - Group 3, 1 in 8 internal taper to 18T (BF3, ML52)
10026	Spline sleeve - Group 2, 14T, 4mm keyway
35505	Spline sleeve - 13T/18T (BF3/13)

## Failsafe Brakes

- The failsafe brake is spring loaded to apply the brake, and hydraulic pressure is required to release or ‘hold off’ the brake. Normal operation is to have the brake pressurised in the released position with the vehicle system running.
- Any function, which reduces the hydraulic system pressure below the release pressure of the brake, will initiate the brake application.

### Failsafe Brakes - Ausco



Model	Torque <i>Nm</i>	Min/max release press. <i>bar</i>	Int. Spline Motor end	Ext. Spline Reduction end
75125	429	14 / 17	SAE ‘A’, 1” 6B	SAE ‘B’, 7/8” 13T
75260	294	10 / 12	SAE ‘B’, 7/8” 13T	SAE ‘B’, 7/8” 13T
37325	1017	13 / 16	SAE ‘A’, 1” 6B	SAE ‘C’, 1 1/4” 14T
76264	373	8 / 10	SAE ‘C’, 1 1/4” 14T	SAE ‘C’, 1 1/4” 14T

- Numerous model variations, torque and mount options available on indent.
- Spare Ausco parts available – stack, gasket and O-ring kits – contact Hyspecs.

### Failsafe Brakes – MICO



Model	Torque <i>Nm</i>	Min/max release press. <i>bar</i>	Int. Spline Motor end	Output shaft
13-587-006	904	14.5 / 21.4	2k bearing less	Wheel mount 1 1/2" taper
13-587-094	2260	34 / 46	4k bearing less	Wheel mount 1 1/2" taper
13-587-100	2937	34 / 46	4k bearing less	Wheel mount 1 1/2" taper

- Spare MICO brake parts available – contact Hyspecs.

## Spline Billets & Shafts - Hub-City

- Splined hubs are machined true on O.D. to spline axis for pressing or welding into drive components.
- Supplied in soft condition, they may be induction hardened or carburised. Manufactured from K1146 or K1050 material.



### Hubs

Model	Description	Hub O.D mm	Hub Length mm
03-32-00031	6B x 1"	50.8	44.5
03-32-00032	9T x 5/8"	31.8	31.8
03-32-00033	13T x 7/8"	38.1	38.1
03-32-00034	14T 1 1/4"	57.2	50.8
03-32-00035	21T x 1 3/8"	57.2	54.0
03-32-00037	16T x 2 1/8"	89.0	75.4
03-32-00071	11T x 3/4"	38.1	38.1
03-32-00072	15T x 1"	44.5	44.5
03-32-00073	23T x 1 1/2"	57.2	54.0
03-32-00074	13T x 1 3/4"	76.2	57.2
03-32-00075	27T x 1 3/4"	76.2	57.2
03-32-00085	18T x 25mm	44.5	44.5
03-32-00093	17T x 1 1/2"	57.2	69.9

### Shafts

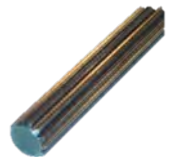

Model	Description	Shaft Length mm
03-32-00023	9T x 5/8"	152
03-32-00024	13T x 7/8"	152
03-32-00025	14T 1 1/4"	254
03-32-00044	15T x 1"	203
03-32-00390	6B x 1"	254

### Reducing Bushes



Model	Description
02-23-02149-330	1 1/4" x 14T to 5/8" x 9T
02-23-02148-330	1 1/4" x 14T to 7/8" x 13T

## Flexible Couplings / Bell Housings / Damping



### ND Aluminium Series - OMT

- Cast alloy with flexible rubber insert, pre-bored to suit 1:8 taper or SAE shafts and UNEL electric motors.

Model/Parts Required	Pump Shaft	Motor Shaft mm	Frame Size	Rubber Ø mm
ND 2	Grp. 1 Taper	14	71	42
ND 5	Grp. 1 Taper	19	80	62
ND 8	Grp. 1 Taper	24	90	62
ND 11	Grp. 1 Taper	28	100 - 112	62
ND 7	Grp. 2 Taper	19	80	62
ND 10	Grp. 2 Taper	24	90	62
ND 13	Grp. 2 Taper	28	100 - 112	62
ND 14	Grp. 2 Taper	28	100 - 112	82
ND 16	Grp. 2 Taper	38	132	82
ND 43A	Grp. 2 Taper	42	160	103
ND 17	Grp. 3 Taper	38	132	82
ND 43C	Grp. 3 Taper	42	160	103
ND 44C	Grp. 3 Taper	48	180	103
ND 40	Grp. 3 Taper	55	200	103
ND65BG1 + R-62 + ND65H4D11	5/8" Parallel	24	90	62
ND65BG1 + R-62 + ND65H4D22	3/4" Parallel	24	90	62
ND65CG1 + R-62 + ND65H4D22	3/4" Parallel	28	100 - 112	62
ND65BG1 + R-62 + ND65H9C99	7/8" Parallel	24	90	62
ND86AG1 + R-82 + ND86HC27	7/8" Parallel	28	100 - 112	82
ND86BG1 + R-82 + ND86HC27	7/8" Parallel	38	132	82
ND108BG1 + R-103 + ND108H2C98	1¼" Parallel	42	180	103
ND108CG1 + R-103 + ND108HC98	1¼" Parallel	48	180	103

### POL Steel Series - OMT

- Steel couplings with polyamide sleeve, pre-bored or blank coupling halves. Designed to establish a connection between an electric motor and hydraulic pump. Mix and match to get the desired assembly.



OMT3 – 112.8Nm@3000rpm (35.4kW)
<b>Sleeve</b>
POL-3
<b>Motor Half</b>
OMT3060C – blank
OMT3060C36 – 28mm, 100/112 frame
<b>Pump Half</b>
OMT3060C22 – SAE A 3/4"
OMT3060SE07 – SAE A 9T
OMT3060C – blank

OMT4 – 186.4Nm@3000 rpm (58.5kW)
<b>Sleeve</b>
POL-4
<b>Motor Half</b>
OMT4080C – blank (or pump half)
OMT4080C47 – 38mm, 132 frame
<b>Pump Half</b>
OMT4080C22 – SAE A 3/4"
OMT4080C27 – SAE B 7/8"
OMT4080SE10 – SAE B 13T
OMT4080SE11 – SAE B 15T

(continued on next page)

## Flexible Couplings / Bell Housings / Damping



### POL Steel Series – OMT (continued)

<b>OMT5 – 269.8Nm@3000rpm (84.5kW)</b>
<b>Sleeve</b>
POL-5
<b>Motor Half</b>
OMT5080C – blank (or pump)
OMT5110C51 – 42mm, 160 frame
OMT5110C54 – 48mm, 180 frame
<b>Pump Half</b>
OMT5060C22 – SAE A 3/4" Parallel
OMT5060C28 – SAE B 7/8" Parallel
OMT5060C40 – SAE C 1 1/4" - short
OMT5060SE04 – SAE C 14T - short
OMT5060SE10 – SAE B 13T - short
OMT5060SE11 – SAE B 15T - short
OMT5080C40 – SAE C 1 1/4" - long
OMT5080SE04 – SAE C 14T - long
OMT5080SE06 – SAE CC 17T
OMT5080SE10 – SAE B 13T

<b>OMT6 – 412.4Nm@3000 rpm (130kW)</b>
<b>Sleeve</b>
POL-6
<b>Motor Half</b>
OMT6080C56 – 55mm, 200 frame
OMT6080C57 – 60mm, 225 frame
OMT6080C58 – 65mm, 250 frame
OMT6110C – blank
OMT6110C56 – 55mm, 200 frame
OMT6080C58 – 65mm, 250 frame
<b>Pump Half</b>
OMT6080C40 – SAE C 1 1/4"
OMT6080SE04 – SAE C 14T
OMT6080SE06 – SAE C 17T
OMT6110C39 – SAE C 1 1/4"
OMT6080SE06 – SAE CC 17T
OMT6110C – blank

### Bell Housings – OMT

- Cast alloy, pre-tapped to suit pumps with European style 4 bolt or SAE mounts.

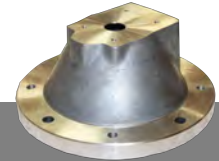

Model	Motor Flange mm	Frame Size	
LS161	160	71	Grp. 1 Euro
LS201	200	80 - 90	Grp. 1 Euro
LS203	200	80 - 90	Grp. 2 Euro
LS250	250	100 - 112	Grp. 1 Euro
LS252	250	100 - 112	Grp. 2 Euro
LS255	250	100 - 112	Grp. 3 Euro
LS300	300	132	Grp. 2 Euro
LS302	300	132	Grp. 3 Euro
LS350	300	160	Grp. 2 Euro
LS352	350	160 - 180	Grp. 3 Euro
LSE401	400	200	Grp. 3 Euro
TH1-825A	200	80 - 90	SAE 'A'
TH15-101A	400	200	SAE 'B'
TH20A-453A	200	80-90	HALDEX 4 bolt
B20Q1A101A	200	80 - 90	SAE 'B'
TH2-825A	250	100 - 112	SAE 'A'
TH2-101A	250	100 - 112	SAE 'B'
TH2-127A	250	100 - 112	SAE 'C'
TH3-825A	300	132	SAE 'A'
TH3-101A	300	132	SAE 'B'
TH3-127A	300	132	SAE 'C'
TH3-101A	300	132	SAE 'B'
TH3-127A	300	132	SAE 'C'
TH4-825A	350	160 - 180	SAE 'A'
TH4-101A	350	160 - 180	SAE 'B'
TH4-127A	350	160 - 180	SAE 'C'
TH4-127C	350	160-180	SAE 'C' 4B

## Flexible Couplings / Bell Housings / Damping

### Couplings & Bell Housings for Petrol Engines – OMT

- Bell-housings and cast alloy coupling with flexible rubber insert, pre-bored to suit 1:8 taper or SAE pump shafts and appropriate petrol engine output shaft.



Bell Housing	Coupling	To Suit Engine	To Suit Pump
LMH150-GC	252835 + R-42 + 252836	5.5HP Honda	GC Series 4 bolt
LMH151	ND 510	5.5 HP Honda	Grp.1, Taper, Euro
LMH151	ND 511	5.5 HP Honda	Grp.1, 12mm, Euro
LMH401	ND 610	8-13 HP Honda	Grp.1, Taper, Euro
LMH403	ND 613	8-13 HP Honda	Grp.2, Taper, Euro
LB152-825A	ND 710	7-18 HP Kohler	SAE A, 3/4" parallel
LB152-U1P	ND 600	7-18 HP Kohler	Grp.1, Taper, Euro
LB152-2	ND 603	7-18 HP Kohler	Grp.2, Taper, Euro



### Bell Housing Adaptor GC Pump – HYSPECS

Bell Housing	To Suit Engine	To Suit Pump
HSADP2	8-13HP Honda	GC Series 4 bolt

### Damping Rings for Power Packs – OMT

- Consist of two metal rings moulded into vulcanized rubber. Interposed between the bell housing and the tank cover, they diminish the noise created by the power transmission by approx. 3 - 5 dB. The rubber is mineral oil resistant with a maximum working temperature of 80°C.



Model	Diameter <i>mm</i>	To Suit Electric Motor Frame Size
A-200	200	80 - 90
A-250	250	100 - 112
A-300	300	132
A-350	350	160 - 180

## Flexible Couplings / Bell Housings / Damping

### Damping Rods for Foot Flange Motors – OMT

- Consist of two metal bars moulded into vulcanized rubber. Interposed between the OMT foot flange and oil tank cover or between the motor and ground where vibrations are higher, they diminish the noise created by the power transmission by approx. 3 - 5 dB. The rubber is mineral oil resistant with a maximum working temperature of 80°C.



Model	Dimensions (LxWxH) mm	To Suit Electric Motor Frame Size
BMA-132S-F	288 x 53 x 45	132S
BMA-132M-F	288 x 53 x 45	132M
BMA-160M-F	343 x 73 x 60	160M
BMA-160L-F	419 x 73 x 60	160L
BMA-180M-F	419 x 73 x 60	180M
BMA-180L-F	446 x 73 x 60	180L
BMA-200L-F	500 x 73 x 60	200L
BMA-225S-F	500 x 73 x 60	225S
BMA-225M-F	500 x 73 x 60	225M

### Foot Flanges – OMT

- Manufactured of high resistance aluminium alloy, these foot flanges are used to support OMT bell housings.



Model	PCD mm	To Suit Electric Motor Frame Size
P160	130	71
P200	165	80/90
P250	215	100/112



## Contents Section J – Oil Reservoirs

### **J1 Oil Reservoirs**

J1	CP Aluminium Series	<i>OMT</i>
J1	HSP-HT Aluminium Series	<i>Hyspecs</i>
J2	VWR Smart Reservoirs	<i>Smart Reservoir</i>

## Oil Reservoirs

### OMT - Aluminium Oil Reservoirs

- Die cast aluminium
- Complete with lid and gasket
- The lid is left blank to allow the designer to cut appropriate holes for the electric motor, filters, filler/breather and any other bulk head accessories that may be required.
- Nominal capacity corresponds to  $\frac{3}{4}$  of total capacity
- Drain plug



Model	Volume		Overall Dimensions			
	litres - Nom	Length - mm	Width - mm	Height - mm	Lid - mm	
CP16GC	16	368	290	243	5	
CP25MGC	25	490	340	285	5	
CP55GC	33	515	415	315	6	
CP75GC	52	605	465	365	6	
SE350 G	Inspection Cover (Aluminium), Ø 350mm, 4 x holes 11.5 mm, centres Ø324mm, 18.5mm thick					

### Hyspecs - Aluminium Oil Reservoirs

- 100-200 litres nominal capacity
- Material: Aluminium
- Outward top flange with Nylock nuts and bolts
- Sloped bottom floor for easy draining via removable steel plug
- Baffles available on request (extra cost)
- Sealon adhesive tape that customer installs to provide dust proof and waterproof lid seal
- Pre-drilled bolt down holes



Model	Volume		Overall Dimensions			
	Litres - Nom	Length - mm	Width - mm	Height - mm	Lid - mm	
HSP-HT100	100	780	450	500	6	
HSP-HT150	150	880	500	550	8	
HSP-HT200	200	980	500	650	8	

#### Configuration Options

- Hyspecs aluminium reservoirs - Lids are not included, please contact Hyspecs for pricing
- Plain or a range of pre-cut lids are available

# Oil Reservoirs

## VVR - Smart Reservoirs

### Alternative To Bulky Oil Tanks

Hyspecs can now offer you an alternative to bulky oil tanks and using large quantities of hydraulic oil.

A VVR Smart Reservoir can help you:

- Reduce volume down to 20 times and weight up to 100 times!
- Reduce the size and weight of your hydraulic system
- Reduce the risk to the environment in the event of an oil leak
- Stop oil contamination from dusty, humid or salty air
- Increase the life of your fluid and components by up to 5 times



For example your standard 200L hydraulic tank could be replaced with a VVR weighing 16 kg when filled with oil! These reservoirs have been used successfully since 2008 on various hydraulic systems such as drill rigs and are suitable for mobile, industrial and marine applications where weight or quantity of oil stored is critical.

Model	Volume <i>litres</i>	Description
VVR400-BV-LSM8-AC	6.6	SMART RESERVOIR 6.6 L SAE-16 BALL VALVE

## Contents Section K - Excavator Valving & Accessories

### **K1 Introduction**

### **K2 Hydraulic Pilot Valves**

- K2 Pilot Valve for Auxiliary Spool - HS9501
- K3 Two Stage Pilot Control of Main Spool - HS9515
- K4 Proportional Pilot Control - HS9525
- K5 Joystick Pattern Changer - HS9526/HS9527
- K6 Proportional Hydraulic Controllers, Foot Operated – SVM500 Series
- K7 Proportional Hydraulic Controllers, Single Axis, Stackable, Hand Operated – SVM100 Series
- K8 Proportional Hydraulic Controllers, Dual Axis, Single Lever Hand Operated – SVM400 Series
- K9 Multi-Function Ergonomic Handles

### **K10 Quickhitch Valves**

- K10 Quickhitch Valve – Single Acting - HS9503
- K11 Quickhitch Valve – Double Acting - HS9501

### **K12 Quickhitch Combination Valves**

- K12 Quickhitch, Tilt (Low Flow) & Thumb Valve with Relief Protection - HS9507
- K13 Quickhitch & Tilt Valve with 5-Port Relief (Low Flow) - HS9508
- K14 Quickhitch & Tilt Valve with 4-Port Cross-line Relief (Low Flow) - HS9509
- K15 Two Inlets, Quickhitch & Thumb or Tilt Valve, 5-Port Relief (High Flow) - HS9518

### **K16 Tilt Control Valves**

- K16 Tilt Control Valve with 4-Port Cross-Line Relief (Low Flow) - HS9502
- K17 Tilt Control Valve with 4-Port Cross-Line Relief (Medium Flow) - HS9516
- K18 Tilt Control Valve with 5-Port Relief (Low Flow) - HS9505
- K19 Load Sense Tilt Control Valve with 5-Port Relief (Medium Flow) - HS9506

### **K20 Tilt & Thumb Valves**

- K20 Load Sense Tilt or Thumb Control Valve with Dual Counterbalance - HS9521
- K21 Tilt & Thumb Control Valve with Relief Protection (Low Flow) - HS9504
- K22 Thumb or Tilt Control Valve with 5-Port Relief (High Flow) - HS9512

### **K23 Flow Sharing Valves**

- K23 Dual Pump Flow Sharing Valve - A/HS8222P12GRCS
- K24 Dual Pump Higher Flow Sharing Valve - A/HS8223P16GRCS

### **K25 Excavator Hose Burst Safety Valves**

- K25 SAFEX™ Valves

### **K27 Relief Valves**

- K27 4-Port Cross Line Relief Valves
- K29 5-Port Cross Line Relief Valves

## Excavator Valving & Accessories

### Introduction

- **Hyspecs manufactures custom designed cartridge valve manifolds specifically to control excavator attachments and meet safety standards. Hand and foot controls can be added to the excavator to effectively control new attachments.**
- **Features:**
  - Compact design allows valving to be positioned in confined spaces where others do not fit.
  - Manifold design minimises oil leakage paths
  - Reliable low current draw solenoids provide millions of cycles lifetime
  - Hardened spools and cages for longer life
  - All work ports are located on single block face
  - Can be operated continuously in temperatures up to 100°C without challenging the coils insulation.
  - Integral pressure reducing/relieving valves guard against pressure spikes and thermal shock.
  - Low pressure drops
- **Material:**
  - Aluminium or steel for pressures up to 240 bar and 350 bar respectively.
  - All steel blocks are nickel plated to protect your investment.

### Model Order Code

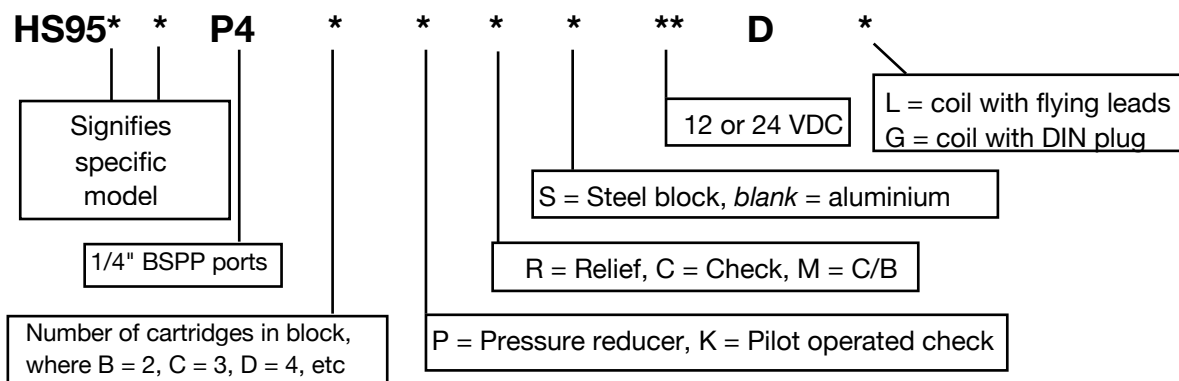

- **Hyspecs stocks Walvoil proportional hydraulic pilot controls.** Hand and foot operated, single and dual axis controls and multi-function ergonomic handles. See pages 6-9.
- **Hyspecs manufactures hose burst safety valves (SAFEX™ Valves) specifically for excavators -** these valves prevent uncontrolled lowering of the boom/stick cylinders in the event of a hose burst, thereby becoming part of the load holding and lowering system designed to comply with **AS 1418.8 / ISO 8643**. See pages 25-26.
- **Hyspecs manufactures cross line relief valves –** specifically designed to protect tilt and thumb cylinders from being damaged due to excessive external loading. See pages 28-32.

## Hydraulic Pilot Valves

### Pilot Valve for Auxiliary Spool - HS9501

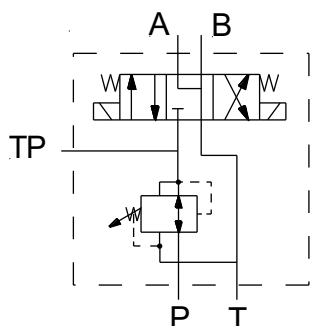

- Pilot valves are used to provide pilot pressure to the auxiliary spool on an excavator. Auxiliary spools are often used to attach rotating grapples. This valve gives the operator fingertip control of that new attachment. A pressure reducer/reliever provides the user with a means of setting up the desired flow with proportional auxiliary spools.

Model	Description	Q max l/min	P max bar	Voltage DC
HS9501P4BP**DL	Pilot valve, aluminium, flying leads	11	207	12 or 24
HS9501P4BP**DG	Pilot valve, aluminium, DIN plug with LED	11	207	12 or 24

\*\* Denotes coil voltage

- Valve includes alloy manifold block, 1 x 4-way 3-position solenoid cartridge valve and coils and 1 x pressure reducer/reliever.
- 5 ports, A, B, P, T and TP, all ¼" BSPP
- Valve overall dimensions, 248mm x 63mm x 51mm (L x W x H)
- Electro-proportional directional cartridge option is available – *Consult Hyspecs*

Spare Components	Description
HS9501P4BP_B	Pilot manifold, aluminium
PR10-32A-0-N-04 or	Pressure reducer/reliever (5.5 – 27.6 bar)
PR10-32A-0-N-08	Pressure reducer/reliever (13.8 – 55.2 bar)
SV08-47D-0-N-0	4-way, 3-position solenoid valve (P blocked, A & B to T in neutral)
6306012	12 VDC coil, 8 size, DIN plug
6306024	24 VDC coil, 8 size, DIN plug
6302012	12 VDC coil, 8 size, flying leads
6302024	24 VDC coil, 8 size, flying leads
ISOL-30R	DIN plug to suit DC coils

- E coils and other terminations available – *Consult Hyspecs*

## Hydraulic Pilot Valves

### Two Stage Pilot Control of Main Spool - HS9515

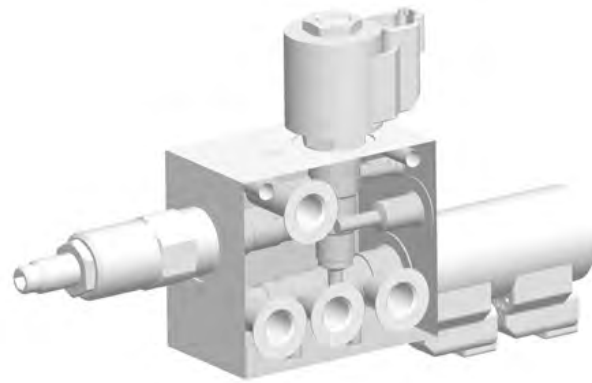
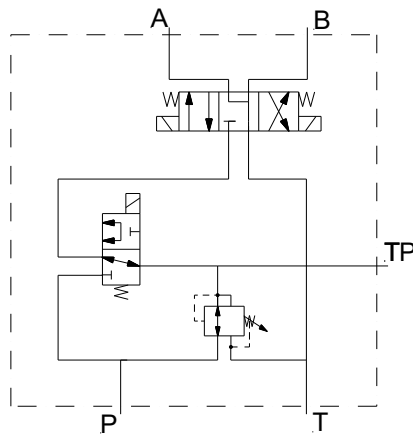

- Designed to control the main spool of an excavator, partial flow or full flow.

Model	Description	Q max l/min	P max bar	Voltage DC
HS9515P4CP**DL	Pressure reducer, 3-position solenoid valve and 2-position 3-way solenoid selector, flying leads	11	207	12 or 24
HS9515P4CP**DG	Pressure reducer, 3-position solenoid valve and 2-position 3-way solenoid selector, DIN plug with LED	11	207	12 or 24

\*\* Denotes coil voltage

- Valve includes aluminium manifold, 1 x 3-way 2-position solenoid cartridge with coils and 1 x pressure reducer/reliever.
- 5 ports, P, T, A, B & TP, all ¼" BSPP
- Valve overall dimensions, 299mm x 122mm x 50mm (L x W x H)

Spare Components	Description
HS9515P4CP	Two stage pilot control manifold, aluminium
PR08-32A-0-N-04 or	Pressure reducer/reliever (5.5 – 27.6 bar)
PR08-32A-0-N-08	Pressure reducer/reliever (13.8 – 55.2 bar)
SV08-47D-0-N-0	4-way, 3-position solenoid valve
SV08-31-0-N-0	3-way, 2-position solenoid valve
6306012	12 VDC coil, 8 size, DIN plug
6306024	24 VDC coil, 8 size, DIN plug
6302012	12 VDC coil, 8 size, flying leads
6302024	24 VDC coil, 8 size, flying leads
ISOL-30R	DIN plug to suit DC coils



## Hydraulic Pilot Valves

### Proportional Pilot Control - HS9525

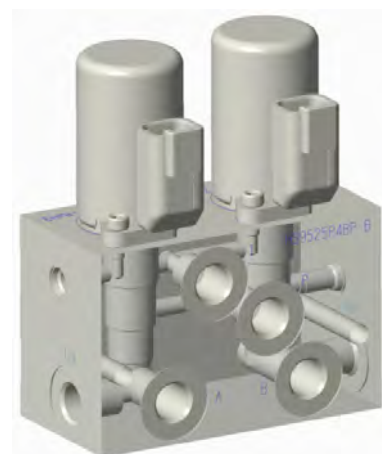
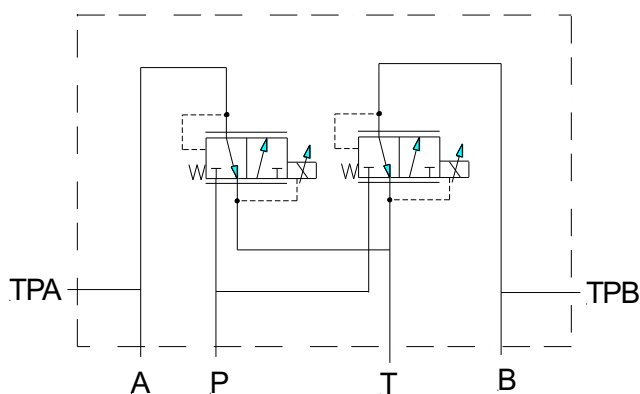

- Designed to provide proportional pilot pressure to the auxiliary spool on an excavator to supply proportional flow to attachments.

Model	Description	Q max l/min	P max bar	Voltage DC
HS9525P4BP**	Proportional pilot valve Aluminium, Deutsch connector	18	240	12 or 24

\*\* Denotes coil voltage

- Valve includes alloy manifold block, 2 x proportional reducing/relieving drop-in-style valves with coils and matching Deutsch connectors
- 6 ports, A, B, TPA, TPB, P & T, all 1/4" BSPP
- Valve overall Dimensions: 120mm x 100mm x 50mm
- Plug-In style dual/single valve driver EVDR-0201 as a controller option
- Refer proportional valve controller page for controller options

Spare Components	Description
HS9525P4BP_B	Proportional pilot manifold aluminium
EHPR98-T38B-**ER	Proportional reducing/relieving with coil (0 – 57 bar)
4001417	Deutsch mating connector

## Hydraulic Pilot Valves

### Joystick Pattern Changer - HS9526/HS9527

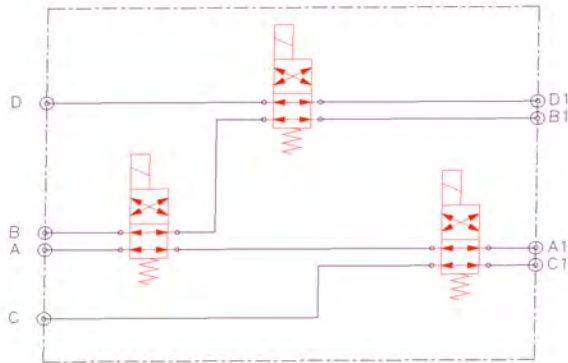

- Designed for joystick pattern changer between Hitachi and ISO.

Model	Description	Q max l/min	P max bar	Voltage DC
HS9526U7C**DL	Three 08, size 2 position, 4-way solenoid valves, flying leads	11	207	12 or 24
HS9526U7C**DG	Three 08, size 2 position, 4-way solenoid valves, DIN plug with LED	11	207	12 or 24
HS9527U7C**DL	Three size 10, 2 position, 4-way solenoid valves with manual override, flying leads	23	207	12 or 24
HS9527U7C**DG	Three size 10, 2 position, 4-way solenoid valves with manual override, DIN plug with LED	23	207	12 or 24

\*\* Denotes coil voltage

- Valve includes aluminium manifold block, 3 x 4-way, 2 position solenoid cartridges and coils
- 8 ports, A, B, C, D & A1, B1, C1, D1, all 7/16" UNO
- Valve overall Dimensions: HS9526 122mm x 120mm x 50mm
- HS9527 178mm x 150mm x 75mm

Spare Components	Description
HS9526U7C	Joystick pattern changer size 8 manifold aluminium
HS9527U7C	Joystick pattern changer size 10 manifold aluminium
SV08-40-0-N-0	4-way, 2 position solenoid valve
SV10-40M-0-N-0	4-way, 2 position solenoid valve with manual override
63060**	12 or 24 VDC coil, 8 size, DIN plug
63020**	12 or 24 VDC coil, 8 size, flying leads
63560**	12 or 24 VDC coil, 10 size, DIN plug
63520**	12 or 24 VDC coil, 10 size, flying leads
ISOL-30R	DIN plug to suit DC coils

## Hydraulic Pilot Valves

- Walvoil remote hydraulic controllers allow users to remotely control pilot operated valves and pilot operated pump servos.
- Working on pressure reducing principles, Walvoil hydraulic remote controllers can be configured to a pressure control range to suit the majority of applications. Pressure range settings are field convertible.
- Consult Hydraulic Specialties for the range of control springs available and metering curve information.
- Remote controllers can be configured with ancillary electrical control options to combine a machine's control interface into a single compact package.

### Proportional Hydraulic Controllers - Foot Operated - SVM500 Series

Pedal hydraulic pilot valves, available in different configurations. High sensitivity and low force, reduced weight. For agricultural and earth moving machines.

The SVM500 series works according to the principle of direct-acting pressure reducing valves. In rest position, the foot pedal is held in neutral by return spring; inlet port P is closed, and ports are connected to tank port T. All 1/4" BSP Ports are located under the body opposite the pedal.

Code	Model	Description	Control Press. bar	Max. Flow lpm	Max. Press. bar
181540001	SVM510-B/00001C	Foot Pedal Single Acting Function	5.8 to 22	20	100
181530001	SVM500-B/01F-00001C	Foot Pedal Dual Acting Function	5.8 to 22	20	100

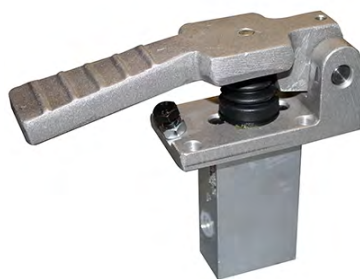

SVM510  
Hydraulic circuit



SVM500  
Hydraulic circuit

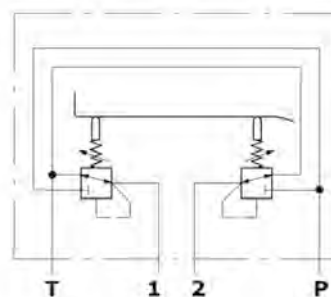

## Hydraulic Pilot Valves

### Proportional Hydraulic Controllers, Single Axis, Stackable, Hand Operated - SVM100 Series

Low operating efforts, energy consumption and maintenance make these hydraulic remote controls ideal for piloting remote control directional valves, variable displacement pumps/motors, auxiliary valves, friction and hydraulic brakes. Multiple hydraulic remotes are assembled with tie rod kits. Valves come standard up to 4 working sections with a maximum of up to 10 working sections on request – contact Hyspecs.



Code	Model	Description	Control Press. bar	Max. Flow lpm	Max. Press. bar
181121116	SVM100/1-S/07G3-00020A	Single axis 1 controller	4.3 to 15.2	20	100
181122121	SVM100/2-S/07G3-00020A	Single axis 2 controllers	4.3 to 15.2	20	100
181123073	SVM100/3-S/07G3-00020A	Single axis 3 controllers	4.3 to 15.2	20	100
181124045	SVM100/4-B/01G3-00075B	Single axis 4 controllers	5 to 15	20	100

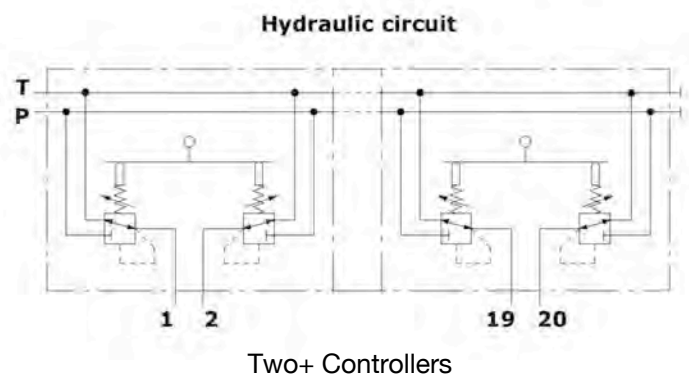
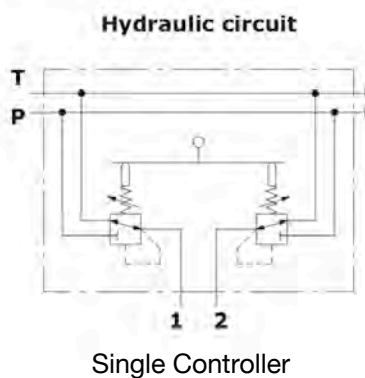

## Hydraulic Pilot Valves

### Proportional Hydraulic Controllers, Dual Axis, Single Lever Hand Operated – SVM400 Series

Hydraulic joystick, double function available with a wide range of handles. Single lever joystick to control two directional control valve working sections.

Code	Model	Description	Control Press. bar	Max. Flow lpm	Max. Press. bar
181420100	SVM400/01-B/01V009-00020A	Dual axis no button	4.3 to 15.2	20	100
181420684	SVM400/01-B/01V209-045-00020A	Dual axis one on/off button, 2A@12V DC	4.3 to 15.2	20	100



Hydraulic circuit

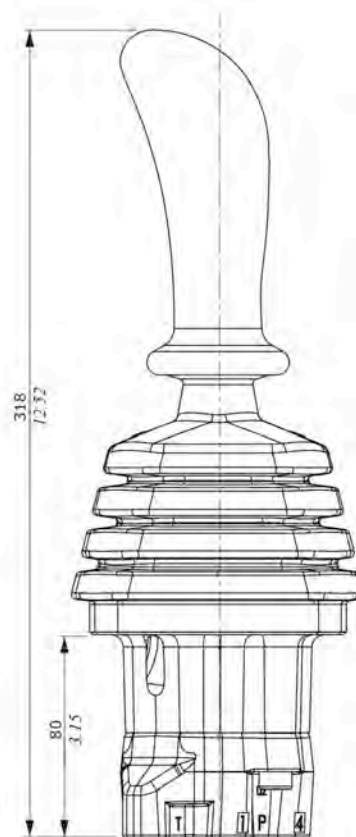
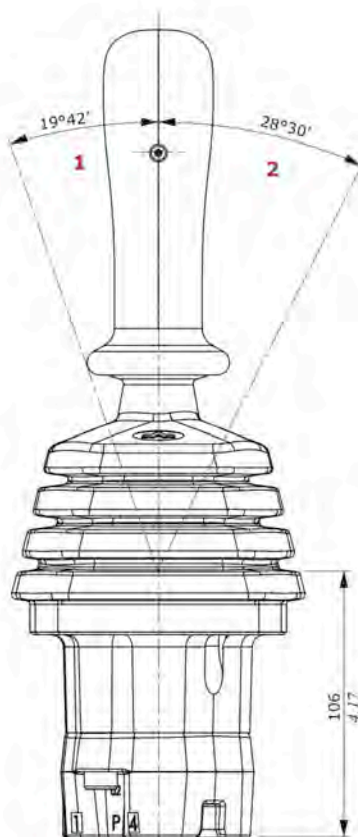
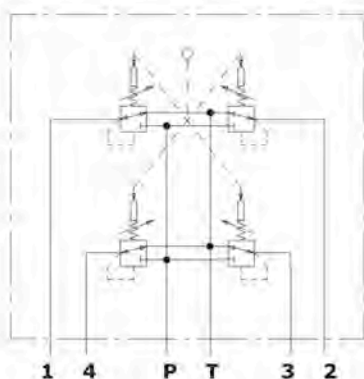

- 1 : Single work port
- 2 : Two simultaneous work ports

## Hydraulic Pilot Valves

### Multi-Function Ergonomic Handles

- Quickhitch, tilt and thumb valves require switching gear to allow the operator control.
- Walvoil remote handles provide this control, with their various switching and handle options.
- M12 mounting adaptor
- Quenching diodes must be used on rocker switches for DC operation.



Code	Model	Description	Suggested Use	Rating
5IMP200000	Series 10	Type X (ON)/OFF push button,	Quick hitch	6A Resistive 4A Inductive @30VDC
5IMP600000	Series 10	Type T 3-position rocker switch ON/OFF/ON, spring centre	Tilt	6A Resistive 4A Inductive @30VDC
2IM4000213	H series	No buttons	Aux.	-
2IM4000235	H series	Ergonomic type 2 ON/OFF push buttons	Tilt	2A Resistive @12VDC
2IM4000003	H series	Ergonomic type 3 ON/OFF push buttons	Quick hitch, tilt or thumb	2A Resistive @12VDC
2IM4000145	H series	Ergonomic type 2 ON/OFF push, 1 rocker switch	Quick hitch, tilt or thumb	2A Resistive @12VDC
2IM4000221	H series	Ergonomic type 4 ON/OFF push buttons	Tilt and thumb	2A Resistive @12VDC
2IM8010034	P Series	Ergonomic type 2 ON/OFF push buttons	Tilt	2A Resistive @12VDC
2IM8010035	P Series	Ergonomic type 1 ON/OFF push buttons	Quick hitch	2A Resistive @12VDC
2IM8500007	P Series	Dead man trigger & 2 prop. rollers		2A Resistive @12VDC
2IM8550004	P Series	Dead man trigger, 1 prop. roller, 2 ON/OFF		2A Resistive @12VDC
5IMP030011	V Series	No buttons	Aux	-
5IMP032012	V series	Ergonomic type 1 ON/OFF push buttons	Quick hitch	4A Resistive @24VDC



## Quickhitch Valves

### Quickhitch Valve - Single Acting - HS9503

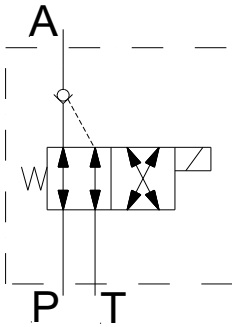

- Single acting quick hitch valves are used to clamp, hold and release excavator attachments via a single acting quick hitch cylinder at the end of the excavator boom.

Model	Description	Q max l/min	P max bar	Voltage DC
HS9503P4BK**DL	S/A Quick hitch valve, aluminium, flying leads	11	207	12 or 24
HS9503P4BK**DG	S/A Quick hitch valve, aluminium, DIN plug with LED	11	207	12 or 24

\*\* Denotes coil voltage

- Valve includes steel manifold block, 1 x 3-way 2-position solenoid valve and coil and a pilot operated check valve.
- 3 ports, A, P and T, 1/4" BSPP
- Valve overall dimensions, 85mm x 37mm x 124mm (L x W x H)

Spare Components	Description
HS9503P4BK	Quick hitch manifold, aluminium
SV08-40-0-N-0	3-way, 2-position solenoid valve
PC08-30-0-N-0	Pilot operated check valve
6306012	12 VDC coil, 8 size, DIN plug
6306024	24 VDC coil, 8 size, DIN plug
6302012	12 VDC coil, 8 size, flying leads
6302024	24 VDC coil, 8 size, flying leads
ISOL-30R	DIN plug to suit DC coils



## Quickhitch Valves

### Quickhitch Valve – Double Acting - HS9501

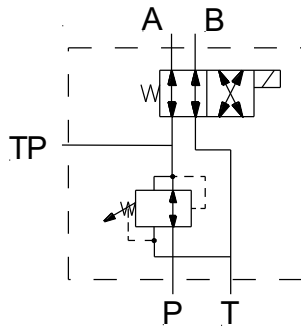

- Quick hitch valves are used to clamp, hold and release excavator attachments via a quick hitch double acting cylinder at the end of the excavator boom.

Model	Description	Q max l/min	P max bar	Voltage DC
HS9501P4BPS**DL	Quick hitch valve, steel, flying leads	11	350	12 or 24
HS9501P4BPS**DG	Quick hitch valve, steel, DIN plug with LED	11	350	12 or 24

\*\* Denotes coil voltage

- Valve includes steel manifold block, 1 x 4-way 2-position solenoid valve and coil and a pressure reducer/reliever.
- 5 ports, A, B, P, T and TP, all 1/4" BSPP
- Valve overall dimensions, 208mm x 63mm x 51mm (L x W x H)

Spare Components	Description
HS9501P4BPS_B	Quick hitch manifold, steel
PR50-36A-0-P-50	Pressure reducer/reliever (207 – 350 bar)
SV08-40-0-N-0	4-way, 2-position solenoid valve
6306012	12 VDC coil, 8 size, DIN plug
6306024	24 VDC coil, 8 size, DIN plug
6302012	12 VDC coil, 8 size, flying leads
6302024	24 VDC coil, 8 size, flying leads
<b>SV58-40-0-P-0</b>	<b>For pressures above 207 bar</b>
6356012	12 VDC coil, 10 size, DIN plug
6356024	24 VDC coil, 10 size, DIN plug
6352012	12 VDC coil, 10 size, flying leads
6352024	24 VDC coil, 10 size, flying leads
ISOL-30R	DIN plug to suit DC coils

## Quickhitch Combination Valves

### Quickhitch, Tilt (Low Flow) & Thumb Valve with Relief Protection - HS9507

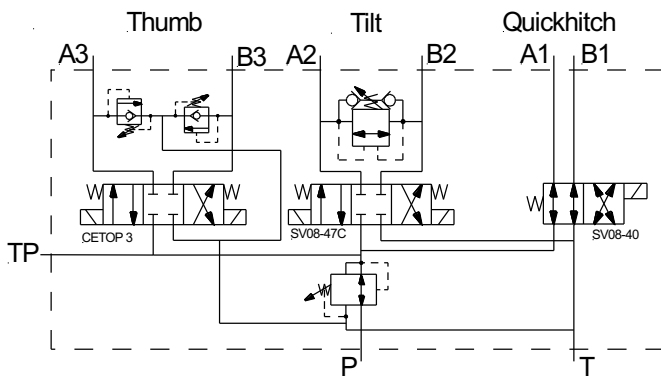

- Designed to control a Quickhitch, Tilt Bucket (low flow) with single acting or equal area ram/s and a Thumb.

Model	Description	Q max l/min	P max bar	Voltage DC
HS9507FPS**DL	Quickhitch, tilt & thumb valve, steel, flying leads, in-built 4-port and 5-port x-line protection	11 & 60	350	12 or 24
HS9507FPS**DG	Quickhitch, tilt & thumb valve, steel, DIN plug with LED, in-built 4-port and 5-port x-line protection	11 & 60	350	12 or 24

\*\* Denotes coil voltage

- Valve includes steel manifold block, 1 x 4-way 3-position solenoid cartridge valve and coils, 1 x Cetop 3 valve, 1 x 4-way 2-position solenoid cartridge valve and coil, 1 x bi-directional relief valve, 2 x relief valves with anti-cav, and 1 x pressure reducer/reliever.
- 9 ports, P, A3, B3 – 3/8" BSPP, A1, B1, A2, B2, TP – 1/4" BSPP, T – 1/2" BSPP
- Valve overall dimensions, 150mm x 170mm x 180mm (L x W x H)
- Electro-proportional directional cartridge option is available – *Consult Hyspecs*

Spare Components	Description
HS9507FPS_B	Quickhitch, tilt and thumb manifold, steel
RVBD-08-N-S-0-50	Bi-directional relief valve (3.5 – 207 bar)
RVPP-10-N-S-0-50	Relief valve with anti-cavitation protection (3.5 – 315 bar)
PR50-38A-0-P-33	Pressure reducer/reliever (maximum setting 207 bar)
SV08-40-0-N-0	4-way, 2-position solenoid valve
SV08-47C-0-N-0	4-way, 3-position solenoid valve (All ports blocked in neutral)
SWH-G02-C2-D**	Cetop 3 valve, 3-position (All ports blocked in neutral)
6306012	12 VDC coil, 8 size, DIN plug
6306024	24 VDC coil, 8 size, DIN plug
6302012	12 VDC coil, 8 size, flying leads
6302024	24 VDC coil, 8 size, flying leads
ISOL-30R	DIN plug to suit DC coils

## Quickhitch Combination Valves

### Quickhitch & Tilt Valve with 5-Port Relief (Low Flow) - HS9508

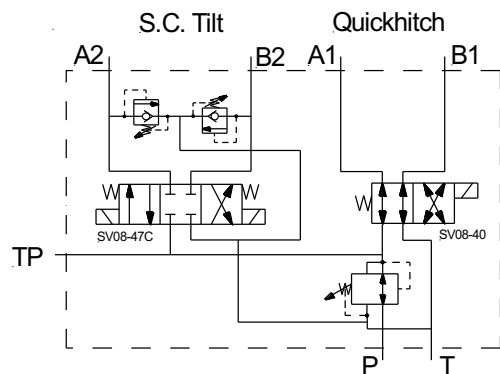

- Designed to control a Quickhitch and Tilt Bucket with a double acting ram/s.

Model	Description	Q max l/min	P max bar	Voltage DC
HS9508P4EPS**DL	Quickhitch and tilt valve, steel, flying leads, in-built 5-port x-line protection	11	350	12 or 24
HS9508P4EPS**DG	Quickhitch and tilt valve, steel, DIN plug with LED, in-built 5-port x-line protection	11	350	12 or 24

\*\* Denotes coil voltage

- Valve includes steel manifold block, 1 x 4-way 3-position solenoid cartridge valve and coils, 1 x 4-way 2-position solenoid cartridge valve and coil, 2 x relief valves with anti-cav, and 1 x pressure reducer/reliever.
- 7 ports, P, TP, T, A1, B1, A2 & B2 all 1/4" BSPP
- Valve overall dimensions, 248mm x 100mm x 137mm (L x W x H)
- Electro-proportional directional cartridge option is available – *Consult Hyspecs*

Spare Components	Description
HS9508P4EPS_B	Quickhitch and tilt with 5-port relief manifold, steel
RVPP-10-N-S-0-50	Relief valve with anti-cavitation protection (3.5 – 207 bar)
PR50-36A-0-P-50	Pressure reducer/reliever (maximum setting 207 bar)
SV08-40-0-N-0	4-way, 2-position solenoid valve
SV08-47C-0-N-0	4-way, 3-position solenoid valve (All ports blocked in neutral)
6306012	12 VDC coil, 8 size, DIN plug
6306024	24 VDC coil, 8 size, DIN plug
6302012	12 VDC coil, 8 size, flying leads
6302024	24 VDC coil, 8 size, flying leads
ISOL-30R	DIN plug to suit DC coils

## Quickhitch Combination Valves

### Quickhitch & Tilt Valve with 4-Port Cross-Line Relief (Low Flow) - HS9509

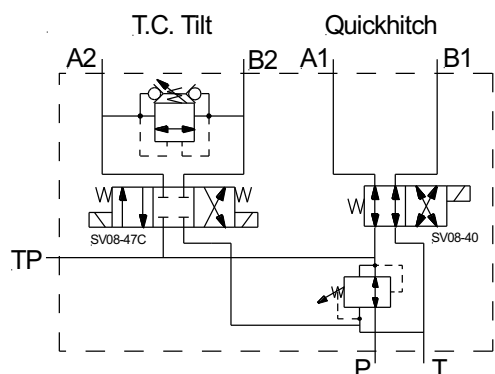

- Designed to control a Quickhitch and Tilt Bucket with twin single acting or equal area ram/s.

Model	Description	Q max l/min	P max bar	Voltage DC
HS9509P4DPS**DL	Quickhitch and tilt valve, steel, flying leads, in-built 4-port x-line protection	2 x 11	350	12 or 24
HS9509P4DPS**DG	Quickhitch and tilt valve, steel, DIN plug with LED, in-built 4-port x-line protection	2 x 11	350	12 or 24

\*\* Denotes coil voltage

- Valve includes steel manifold block, 1 x 4-way 3-position solenoid cartridge valve and coils, 1 x 4-way 2-position solenoid cartridge valve and coil, 1 x bi-directional relief valve and 1 x pressure reducer/reliever.
- 7 ports, P, T, TP, 2 x A & B, all 1/4" BSPP
- Valve overall dimensions, 248mm x 100mm x 105mm (L x W x H)
- Electro-proportional directional cartridge option is available – *Consult Hyspecs*

Spare Components	Description
HS9509P4DPS_B	Quickhitch and tilt with 5-port relief manifold, steel
RVBD-08-N-S-0-50	Bi-directional relief valve (3.5 – 207 bar)
PR50-36A-0-P-50	Pressure reducer/reliever (maximum setting 207 bar)
SV08-40-0-N-0	4-way, 2-position solenoid valve
SV08-47C-0-N-0	4-way, 3-position solenoid valve (All ports blocked in neutral)
6306012	12 VDC coil, 8 size, DIN plug
6306024	24 VDC coil, 8 size, DIN plug
6302012	12 VDC coil, 8 size, flying leads
6302024	24 VDC coil, 8 size, flying leads
ISOL-30R	DIN plug to suit DC coils

## Quickhitch Combination Valves

### Two Inlets, Quickhitch & Thumb or Tilt Valve, 5-Port Relief (High Flow) - HS9518

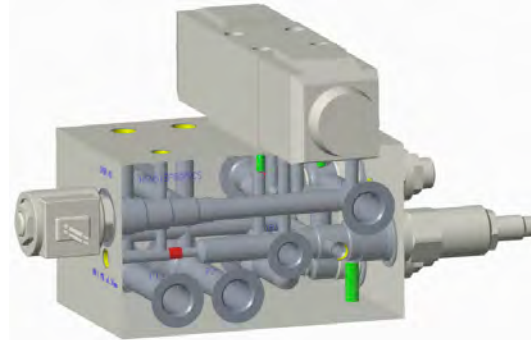
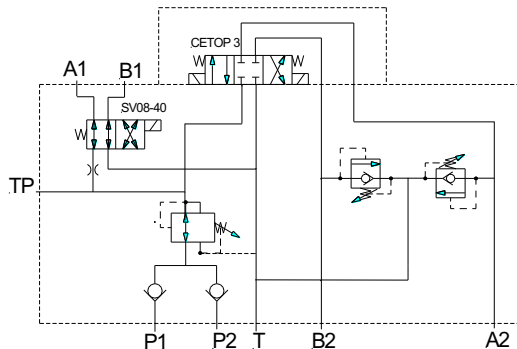

- Designed to control a Quickhitch and Thumb (single D/A ram) or Tilt (High Flow).

Model	Description	Q max l/min	P max bar	Voltage DC
HS9518P6GPRS** DL	Two inlets, Quickhitch & thumb valve, checks, pressure reducer, 2 & 3 position solenoid valves (cetop3 for thumb), 5-port cross line relief valve on the thumb, steel, flying leads	11 & 60	350	12 or 24
HS9518P6GPRS** DG	Two inlets, Quickhitch & thumb valve, checks, pressure reducer, 2 & 3 position solenoid valves (cetop3 for thumb), 5-port cross line relief valve on the thumb, steel, DIN plug with LED	11 & 60	350	12 or 24

\*\* Denotes coil voltage

- Valve includes steel manifold block, 1 x Cetop 3 valve, 1 x 4-way 2-position solenoid cartridge valve and coil, 2 x relief valves with anti-cavitation, 2 x check valves, and 1 x pressure reducer/reliever.
- 8 ports, P1, P2, T, A2 & B2 all 3/8" BSPP, TP, A1 & B1 all 1/4" BSPP
- Electro-proportional directional cartridge option is available – *Consult Hyspecs*
- Valve overall dimensions, 276mm x 109mm x 170mm (L x W x H)

Spare Components	
HS9518P6GPRS	Quickhitch, tilt and thumb manifold, steel
RVPP-10-N-S-0-50	Relief valve with anti-cavitation protection
PR50-38A-0-P-33	Pressure reducer/reliever
SV08-40-0-N-0	4-way, 2-position solenoid valve
CV50-20	High pressure check valve
SWH-G02-C2-D**	Cetop 3 valve, 4-way, 3-position solenoid valve (All ports blocked in neutral)
6306012	12 VDC coil, 8 size, DIN plug
6306024	24 VDC coil, 8 size, DIN plug
6302012	12 VDC coil, 8 size, flying leads
6302024	24 VDC coil, 8 size, flying leads
ISOL-30R	DIN plug to suit DC coils

## Tilt Control Valves

### Tilt Control Valve with 4-Port Cross-Line Relief (Low Flow) - HS9502

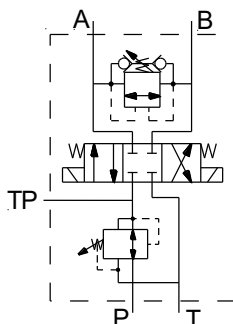

- Designed to control a Tilt Bucket with single acting or equal area ram/s.

Model	Description	Q max l/min	P max bar	Voltage DC
HS9502P4CPS**DL	Tilt valve, steel, flying leads, in-built 4-port x-line protection	11	350	12 or 24
HS9502P4CPS**DG	Tilt valve, steel, DIN plug with LED, in-built 4-port x-line protection	11	350	12 or 24

\*\* Denotes coil voltage

- Valve includes steel manifold block, 1 x 4-way 3-position solenoid cartridge valve and coils, 1 x bi-directional relief valve and 1 x pressure reducer/reliever.
- 5 ports, A, B, P, T and TP, all 1/4" BSPP
- Valve overall dimensions, 248mm x 63mm x 51mm (L x W x H)
- Electro-proportional directional cartridge option is available – *Consult Hyspecs*

Spare Components	Description
HS9502P4CPS	Tilt manifold, steel
RVBD-08-N-S-0-50	Bi-directional relief valve
PR50-36A-0-P-50	Pressure reducer/reliever (maximum setting 207 bar)
SV08-47C-0-N-0	4-way, 3-position solenoid valve (All ports blocked in neutral)
6306012	12 VDC coil, 8 size, DIN plug
6306024	24 VDC coil, 8 size, DIN plug
6302012	12 VDC coil, 8 size, flying leads
6302024	24 VDC coil, 8 size, flying leads
ISOL-30R	DIN plug to suit DC coils

## Tilt Control Valves

### Tilt Control Valve with 4-Port Cross-Line Relief (Medium Flow) - HS9516

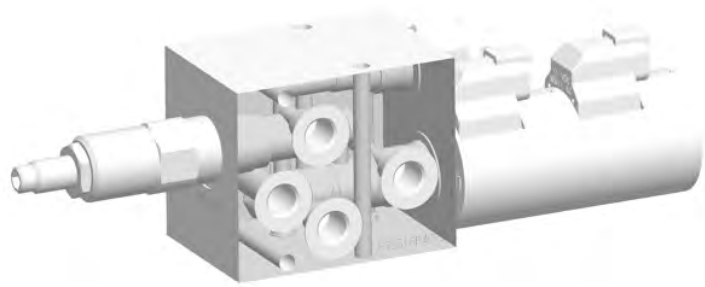
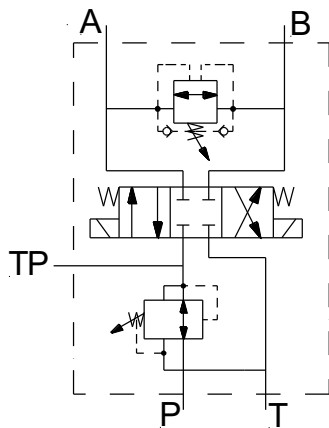

- Designed to control a Tilt Bucket with larger single acting or equal area ram/s.

Model	Description	Q max l/min	P max bar	Voltage DC
HS9516P4CPS**DL	Pressure reducer, 3 position solenoid valve, cross line relief, flying leads	23	350	12 or 24
HS9516P4CPS**DG	Pressure reducer, 3 position solenoid valve, cross line relief, DIN plug with LED	23	350	12 or 24

\*\* Denotes coil voltage

- Valve includes steel manifold, 1 x 4-way 3-position solenoid cartridge and coil, 1 x bi-directional relief valve and 1 x pressure reducer/reliever.
- 5 ports, P, T, TP, A & B, all 1/4" BSPP
- Valve overall dimensions, 254mm x 75mm x 62.5mm (L x W x H)

Spare Components	Description
HS9516P4CPS_B	Tilt control, high flow manifold, steel
PR50-36A-0-P-50	Pressure reducer/reliever (maximum setting 207 bar)
SV10-47C-0-N-0	4-way, 3-position solenoid valve
RVBD-08-N-S-0-50	B-directional relief valve
6356012	12 VDC coil, size 10, DIN plug
6356024	24 VDC coil, size 10, DIN plug
6352012	12 VDC coil, size 10, flying leads
6352024	24 VDC coil, size 10, flying leads
ISOL-30R	DIN plug to suit DC coils



## Tilt Control Valves

### Tilt Control Valve with 5-Port Relief (Low Flow) - HS9505

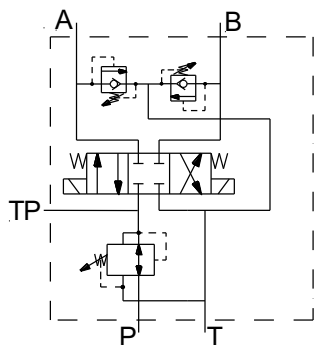

- Designed to control a Tilt Bucket with a differential area cylinder.

Model	Description	Q max l/min	P max bar	Voltage DC
HS9505P4DPS**DL	Tilt valve, steel, flying leads, in-built 5-port x-line protection	11	350	12 or 24
HS9505P4DPS**DG	Tilt valve, steel, DIN plug with LED, in-built 5-port x-line protection	11	350	12 or 24

\*\* Denotes coil voltage

- Valve includes steel manifold block, 1 x 4-way 3-position solenoid cartridge valve and coils, 2 x relief valves with anti-cav, and 1 x pressure reducer/reliever.
- 5 ports, A, B, P, T and TP, all 1/4" BSPP
- Valve overall dimensions, 248mm x 75mm x 117mm (L x W x H)
- Electro-proportional directional cartridge option is available – *Consult Hyspecs*

Spare Components	Description
HS9505P4DPS_B	Tilt with 5-port relief manifold, steel
RVPP-10-N-S-0-50	Relief valve with anti-cavitation protection (3.5 – 207 bar)
PR50-36A-0-P-50	Pressure reducer/reliever (maximum setting 207 bar)
SV08-47C-0-N-0	4-way, 3-position solenoid valve (All ports blocked in neutral)
6306012	12 VDC coil, 8 size, DIN plug
6306024	24 VDC coil, 8 size, DIN plug
6302012	12 VDC coil, 8 size, flying leads
6302024	24 VDC coil, 8 size, flying leads
ISOL-30R	DIN plug to suit DC coils

## Tilt Control Valves

### Load Sense Tilt Control Valve with 5-Port Relief (Medium Flow) - HS9506

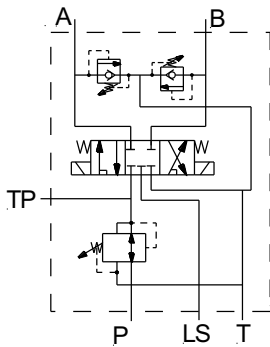

- Designed to control a tilt bucket with a double acting cylinder with in-built load sensing.

Model	Description	Q max l/min	P max bar	Voltage DC
HS9506DPRS**DL	Tilt valve, steel, flying leads, in-built 5-port x-line protection, load sense	23	350	12 or 24
HS9506DPRS**DG	Tilt valve, steel, DIN plug with LED, in-built 5-port x-line protection, load sense	23	350	12 or 24

\*\* Denotes coil voltage

- Valve includes steel manifold block, 1 x 5-way 3-position solenoid cartridge valve and coils, 2 x relief valves with anti-cav, 1 x pressure reducer/reliever cartridge
- 6 ports, A, B, P, TP, LS all 1/4" BSPP and T 3/8" BSPP
- Valve overall dimensions, 213mm x 75mm x 154mm (L x W x H)
- Electro-proportional directional cartridge option is available – Consult Hyspecs

Spare Components	Description
HS9506DPRS_B	Tilt with 5-port relief manifold, steel
RVPP-10-N-S-0-50	Relief valve with anti-cavitation protection (3.5 – 250 bar)
PR50-36A-0-P-50	Pressure reducer/reliever (maximum setting 250 bar)
SV10-57C-0-N-0	5-way, 3-position solenoid valve (All ports blocked in neutral)
6356012	12 VDC coil, 10 size, DIN plug
6356024	24 VDC coil, 10 size, DIN plug
6352012	12 VDC coil, 10 size, flying leads
6352024	24 VDC coil, 10 size, flying leads
ISOL-30R	DIN plug to suit DC coils

## Tilt & Thumb Valves

### Load Sense Tilt or Thumb Control Valve with Dual Counterbalance - HS9521

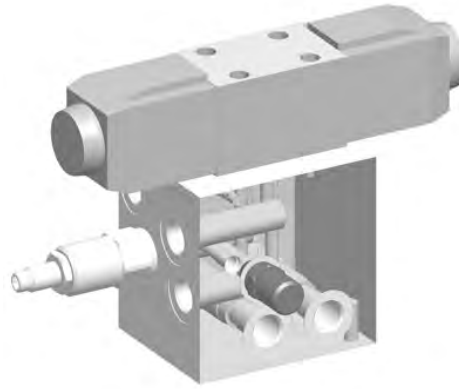
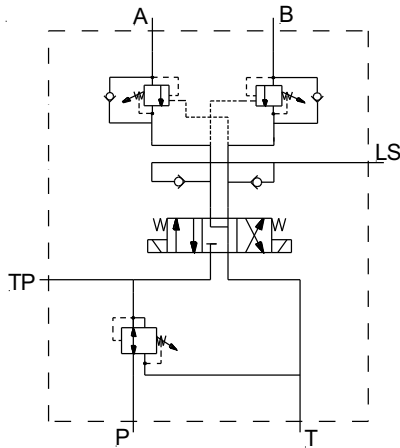

- Designed to control a high flow tilt bucket or thumb with built-in load sense & dual counterbalance.

Model	Description	Q max l/min	P max bar	Voltage DC
HS9521P6FPMS**DG	Pressure reducer, Cetop 3, load sense checks, double counterbalance valves, DIN plug with LED	60	350	12 or 24

\*\* Denotes coil voltage

- Valve includes steel manifold, 1 x Cetop 3 valve, 2 x counterbalance valves, 2 x check valves and 1 x pressure reducer/reliever.
- 6 ports, P, T, A & B all  $\frac{3}{8}$ " BSPP; LS & TP all  $\frac{1}{4}$ " BSPP
- Valve overall dimensions, 179mm x 123mm x 165mm (L x W x H)

Spare Components	Description
HS9521P6FPMS_B	Load sense tilt control with dual counterbalance manifold, steel
CBCG-LJN	Counterbalance valve
PR50-38A-0-P-33	Pressure reducer/reliever (55 – 228 bar)
CV04-20	Load sense check valve
SWH-G02-C4-D**	Cetop 3 valve, 3-position solenoid valve (P blocked, A & B to T in neutral)
NWH-02-D**	12 or 24 VDC coil, DIN plug
ISOL-30R	DIN plug to suit DC coils

## Tilt & Thumb Valves

### Tilt & Thumb Control Valve with Relief Protection (Low Flow) - HS9504

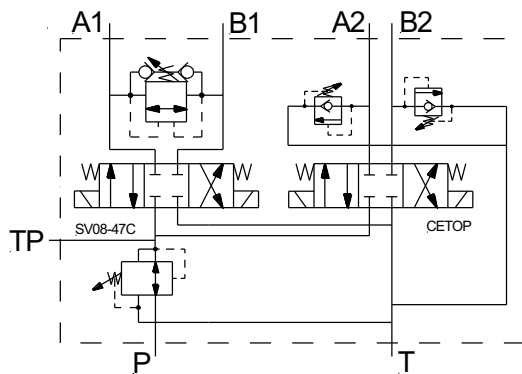

- Designed to control a Tilt Bucket with single acting or equal area ram/s and Thumb.

Model	Description	Q max l/min	P max bar	Voltage DC
HS9504EPS**DL	Tilt & thumb valve, steel, flying leads, in-built 4-port and 5-port x-line protection	11 & 60	350	12 or 24
HS9504EPS**DG	Tilt & thumb valve, steel, DIN plug with LED, in-built 4-port and 5-port x-line protection	11 & 60	350	12 or 24

\*\* Denotes coil voltage

- Valve includes steel manifold block, 1 x 4-way 3-position solenoid cartridge valve and coils, 1 x Cetop 3 valve, 1 x bi-directional relief valve, 2 x relief valves with anti-cav, and 1 x pressure reducer/reliever.
- P ( $\frac{3}{8}$ " BSPP) & T ( $\frac{1}{2}$ " BSPP); TP, A1 & B1 ( $\frac{1}{4}$ " BSPP) and A2 & B2 ( $\frac{3}{8}$ " BSPP)
- Valve overall dimensions, 250mm x 220mm x 180mm (L x W x H)
- Electro-proportional directional cartridge option is available – *Consult Hyspecs*

Spare Components	Description
HS9504EPS_B	Tilt and thumb manifold, steel
RVBD-08-N-S-0-50	Bi-directional relief valve
RVPP-10-N-S-0-50	Relief valve with anti-cavitation protection (3.5 – 315 bar)
PR50-38A-0-P-33	Pressure reducer/reliever (55 – 207 bar)
SV08-47C-0-N-0	4-way, 3-position solenoid valve (All ports blocked in neutral)
SWH-G02-C2-D**	Cetop 3 valve, 4-way, 3-position solenoid valve (All ports blocked in neutral) *Use Eaton Cetop for higher pressure POA.
6306012	12 VDC coil, 8 size, DIN plug
6306024	24 VDC coil, 8 size, DIN plug
6302012	12 VDC coil, 8 size, flying leads
6302024	24 VDC coil, 8 size, flying leads
ISOL-30R	DIN plug to suit DC coils

## Tilt & Thumb Valves

### Thumb or Tilt Control Valve with 5-Port Relief (High Flow) - HS9512

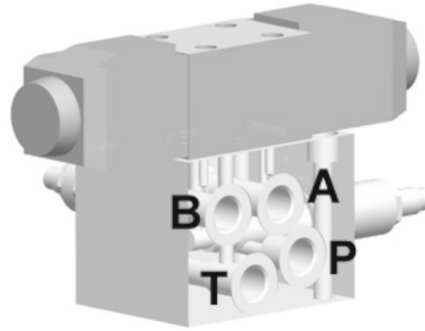
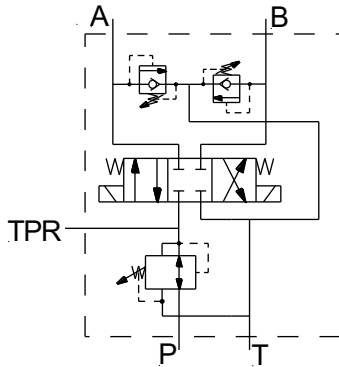

- Designed to control a thumb or tilt via a D/A cylinder.

Model	Description	Q max l/min	P max bar	Voltage DC
HS9512CPRS**	Thumb control of a single D/A cylinder, steel manifold, 5-port x-line protection	60	350	12 or 24

\*\* Denotes coil voltage

- Valve includes steel manifold block, 1 x Cetop 3 valve, 2 x relief valves with anti-cav and 1 x pressure reducer/reliever.
- 5 ports, P, T, A & B all 3/8" BSPP, TPR 1/4" BSPP
- Electro-proportional directional valve option is available – *Consult Hyspecs*

Spare Components	
HS9512CPRS	Thumb manifold, steel
RVPP-10-N-S-0-50	Relief valve with anti-cavitation protection (3.5 – 315 bar)
PR50-38A-0-P-33	Pressure reducer/reliever (55 – 228 bar)
SWH-G02-C2-D**	Cetop 3 valve, 4-way, 3-position solenoid valve (All ports blocked in neutral)

## Flow Sharing Valves

### Dual Pump Flow Sharing Valve - A/HS8222P12GRCS

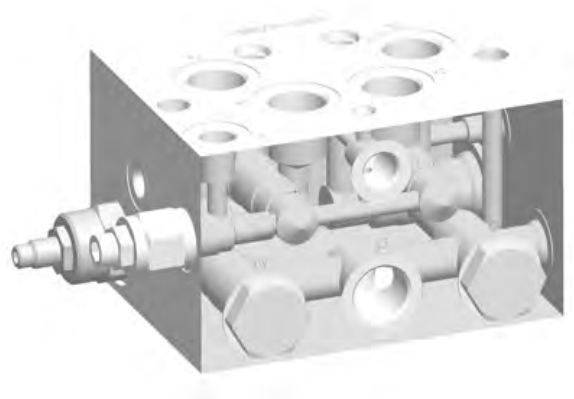
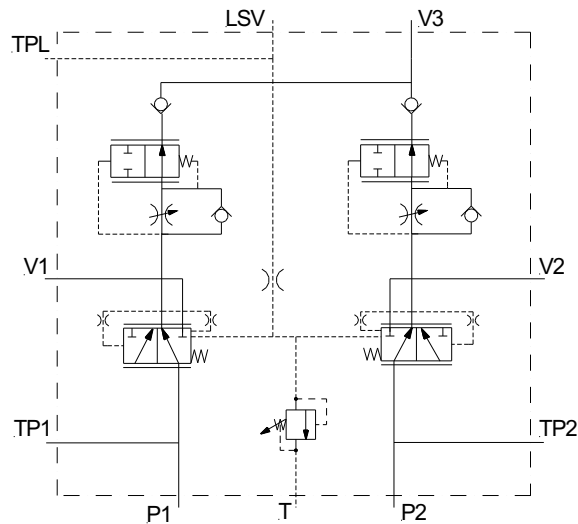

- Designed for high flow (up to 190 LPM) attachment. The valve will deliver priority flow from each main pump to port the attachment (port V3) depending on demand from load sensing line.

Model	Q max l/min	P max bar	Notes	Ports BSPP
A/HS8222P12GRCS	130 x 2 Input	350	Load sense on demand with maximum flow and pressure limiter	3/4" main ports, 3/8" load sense and tank ports, 1/4" test ports

- Manifold dimensions, 165 x 126 x 100mm (excluding cartridges)

Spare Components	Description
HS8222P12GRCS	Dual pump flow sharing manifold, steel
FCVL-12-N-S-0-F	Flow control to limit maximum flow taking
EC12-43-0-N-160	Priority-on-demand pressure compensator
CV11-12	Check valve (02-172411)
RVPD-08	Relief valve (3.5 – 350 bar)

## Flow Sharing Valves

### Dual Pump Higher Flow Sharing Valve - A/HS8223P16GRCS

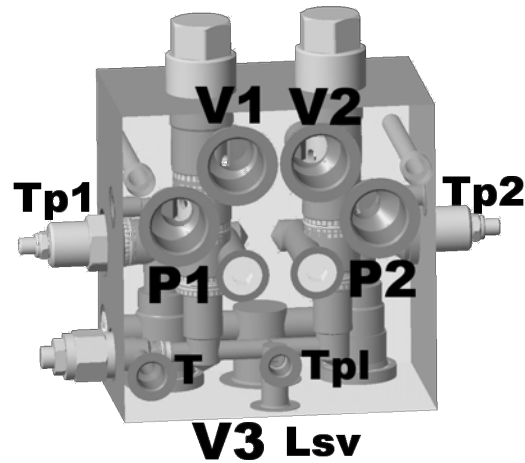
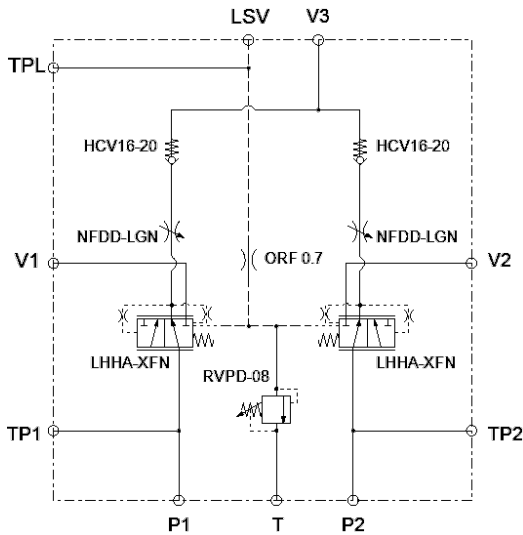

- Designed for higher flow (up to 150 x 2 LPM) attachment. The valve will deliver priority flow from each main pump to the attachment (port V3) depending on demand from load sensing line.

Model	Q max l/min	P max bar	Notes	Ports BSPP
A/HS8223P16GRCS	240 x 2 Input	350	Load sense on demand with maximum flow and pressure limiter	1" main ports, 3/8" load sense and tank ports, 1/4" test ports

- Manifold dimensions, 176 x 176 x 110mm (excluding cartridges)

Spare Components	Description
HS8223P16GRCS*	Dual pump flow sharing manifold, steel
NFDD-LGN*	Flow control to limit maximum flow taking
LHHA-XFN*	Pressure compensator
HCV16-20	Check valve
RVPD-08	Relief valve (3.5 – 350 bar)

- \* Non-common stock item - Contact Hyspecs for lead time



## Excavator Hose Burst Safety Valves

### SAFEX™ Valves

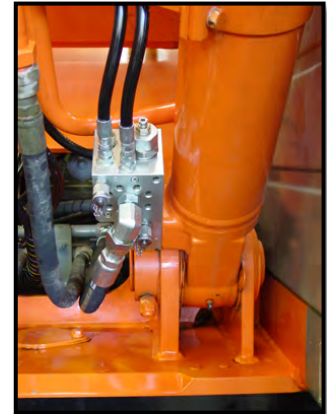

SAFEX™ valves are designed to be mounted directly to the boom and/or the stick (arm) cylinders of hydraulic excavators. With the correct installation and adjustment these valves prevent uncontrolled lowering of the boom/stick cylinders in the event of a hose burst, thereby becoming part of the load holding and lowering system designed to comply with **AS 1418.8 / ISO 8643**.

Model	C	Port Size V	E/EP, PIL, DR	Max. Press. In bar (psi)	Rated Flow Per Valve lpm
A/HS4541P6CR S	BSPP 3/8"	BSPP 3/8"	1/4" BSPP	350 (5000)	30
A/HS4542P8CR S	BSPP 1/2"	BSPP 1/2"	1/4" BSPP	350 (5000)	90
A/HS4543P12C RS	BSPP 3/4"	BSPP 3/4"	1/4" BSPP	400 (5800)	180
A/HS4543U21C RS	UNO 1 5/16"	UNO 1 5/16"	1/4"BSPP	350 (5000)	180
A/HS4881ACRS	SAE 1/2" C61&62	BSPP 1/2"	1/4"BSPP	350 (5000)	90
A/HS4882BCRS	SAE 3/4" C61&62	SAE 3/4" C61&62	1/4"BSPP	350 (5000)	90
A/HS4883BCRS	SAE 3/4" C61&62	SAE 3/4" C61&62	1/4"BSPP	350 (5000)	180
A/HS4884BCRS	SAE 3/4" C61&62	SAE 3/4" C61&62	1/4"BSPP	350 (5000)	300
A/HS4885BCRS	SAE 3/4" C61&62	SAE 3/4" C61&62	1/4"BSPP	350 (5000)	180
A/HS4886CCRS	SAE 1" C61	SAE 1" C61&62	1/4"BSPP	350 (5000)	180
A/HS4887CCRS	SAE 1" C62	SAE 1" C61&62	1/4"BSPP	400 (5800)	180
A/HS4888CCRS	SAE 1" C62	SAE 1" C61&62	1/4" BSPP	400 (5800)	300
A/HS4889CCRS	SAE 1" C62	SAE 1" C61&62	1/4" BSPP	400 (5800)	180
A/HS4890DCRS	SAE 1.25" C62	SAE 1.25" C62	1/4" BSPP	400 (5800)	300
A/HS4891E CRS	SAE 1.5" C62	SAE 1.5" C62	1/4" BSPP	400 (5800)	300
A/HS4847BCRS	SAE 3/4" C61&62	SAE 3/4" C62	1/4" BSPP	350 (5000)	180
A/HS4848CDRS	SAE 1" C62	SAE 1" C62	1/4" BSPP	400 (5800)	360

(continued over page)

## Safety / Load Drop Valves

### SAFEX™ Valve (*continued*)

#### Features and Benefits

- Designed to meet the Australian Safety Regulations for Excavators and complies with ISO 8643.
- Compact design with dual code SAE 61 and 62 ports.
- Relief valve with screen is included for cylinder protection (full flow).
- Duplicated valve (V), pilot (PIL) ports allow the valves to be fitted to either side. End pilot (PIL) and drain (DR) ports make it easy to connect.
- E/TP port on the valves can be used for initial bleed off, a test point to set the relief, manual lowering, and equalizing two boom cylinders.
- Assembled from top quality standard cartridges, which can be purchased in any major city around the world.
- Manufactured by HYSPECS and HYTECH.
- Steel manifolds and Nickel plated
- Tamper proof capable.

**IMPORTANT:** It is the owner's responsibility to ensure that these valves are installed and set correctly in order to comply with the safety standards. Incorrect installation and/or adjustment could result in severe injury, disability or death!

**NB. Contact Hyspecs for Safex Valve technical data sheets and setup procedure.**

## Relief Valves

### 4-Port Cross Line Relief Valves

#### HS1020P8F or 12F

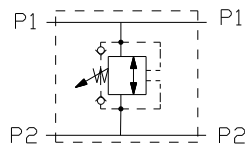
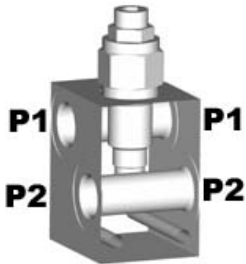

Cartridge Options	Q max l/min	P max bar	Notes	Ports BSPP
RVBD-10	76	350*	Differential poppet	1/2"-3/4"
CR10-28	60	240	Differential poppet	1/2"-3/4"

- Manifold dimensions, 76 x 60 x 50mm for 1/2" and 75 x 75 x 50mm for 3/4" (excluding cartridge)
- \* Requires steel block over 240 bar

#### HS1020P6X

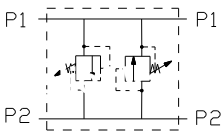

Cartridges	Q max l/min	P max bar	Notes	Ports BSPP
RV10-20 x 2	38	228	Direct acting poppet	3/8"

- Manifold dimensions, 75 x 50 x 37mm (excluding cartridge)

#### HS1020P8Y or P12Y

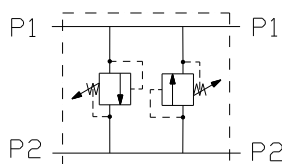
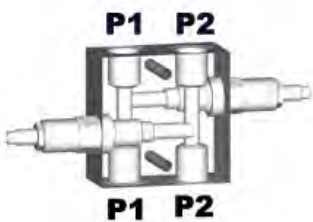

Cartridge Options	Q max l/min	P max bar	Notes	Ports BSPP
RV10-20 x 2	38	228	Direct acting poppet	1/2"-3/4"
RV10-22 x 2	115	240	Differential poppet	1/2"-3/4"
RV5A-10 x 2	114	350*	Pilot operated	1/2" - 3/4"

- Manifold dimensions, 100 x 100 x 50mm (excluding cartridge)
- \* Require steel block over 240 bar

## Relief Valves

### 4-Port Cross Line Relief Valves

#### HS1220P12F

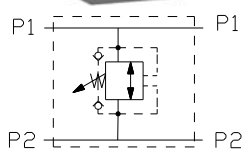
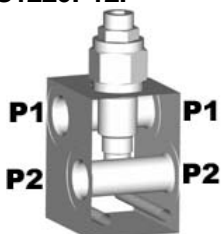

Cartridge Options	Q max l/min	P max bar	Notes	Ports BSPP
RVBD-12	152	350*	Differential poppet	3/4"

- Manifold dimensions, 110 x 75 x 60mm (excluding cartridge)
- \* Requires steel block over 240 bar

#### HS1620U21X

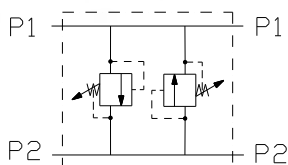
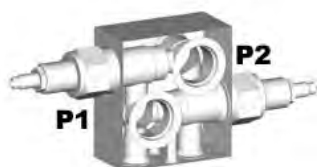

Cartridge Options	Q max l/min	P max bar	Notes	Ports UNO
RV3-16 x 2	300	350*	Differential poppet	1 5/16"
RV5-16 x 2	300	350*	Pilot-operated	1 5/16"

- Manifold dimensions, 110 x 100 x 50mm (excluding cartridge)
- \* Requires steel block over 240 bar

## Relief Valves

### 5-Port Cross Line Relief Valves

#### HS1020P8W

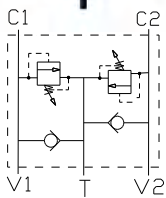

Cartridges	Q max l/min	P max bar	Notes	Ports BSPP
RV10-20 x 2 +CV10-20 x 2	38	228	Direct acting poppet	1/2"
RVD50-20 x 2 +CV50-20 x 2	56	350*	Poppet, low pressure rise	1/2"

- Manifold dimensions, 100 x 100 x 40mm (excluding cartridge)
- Consult Hyspecs for anti-cav performance
- \* Requires steel block over 240 bar – *contact Hyspecs* for pricing

#### HS1020P8ZB or P12ZB or HS1020P8ZB\_B\*\*

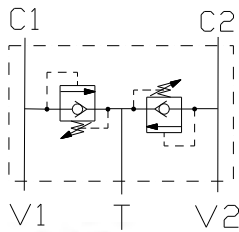

Cartridges	Q max l/min	P max bar	Notes	Ports BSPP
RVPP-10 x 2	100	350*	Pilot operated with in-built check	1/2"- 3/4"

- Manifold dimensions, 80 x 75 x 50mm for P8 and 100 x 75 x 50mm for P12 and 75 x 75 x 60mm for Version B (excluding cartridges)
- \* Requires steel block over 240 bar – *contact Hyspecs* for pricing
- \*\* Version B – main ports centre distance 37mm
- Consult Hyspecs for anti-cav performance

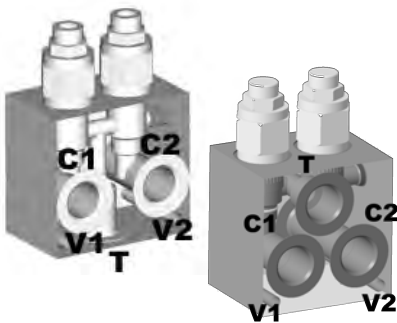

## Relief Valves

### 5-Port Cross Line Relief Valves

#### HS1020P8ZDS

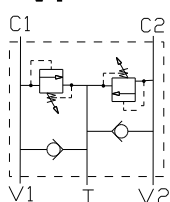
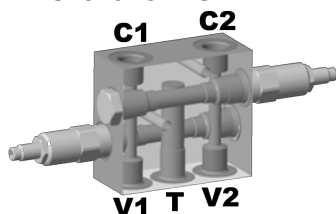

Cartridges	Q max l/min	P max bar	Notes	Ports BSP
RV50-22 x 2 + CV50-20	76	350	Differential relief	1/2"

- Manifold dimensions 110 x 100 x 50mm
- Steel manifold
- Contact Hyspecs for anti-cav performance

#### HS1220P12ZB or HS1220P12ZB\_B\*\*

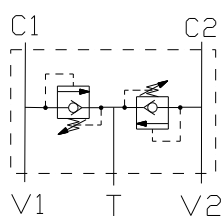

Cartridges	Q max l/min	P max bar	Notes	Ports BSP
RVPP-12 x 2	227	350*	Pilot operated with in-built check	3/4"

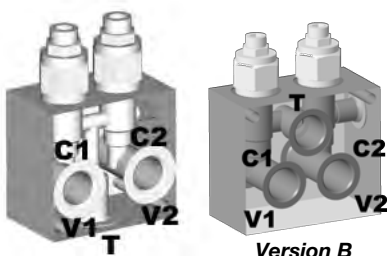

- Manifold dimensions 115 x 100 x 48mm for P12ZB and 115 x 100 x 60mm for P12ZB\_B (Version B) (excluding cartridges)
- \* Requires steel block over 240 bar
- \*\* Version B – main ports centre distance 46mm
- Consult Hyspecs for anti-cav performance

#### HS1620P12ZB2S\*

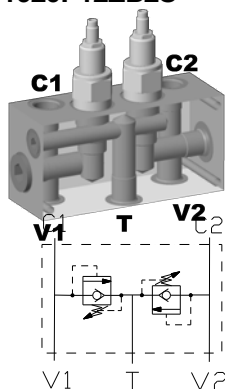

Cartridges	Q max l/min	P max bar	Notes	Ports BSP
RVCV56-20 x 2	115	420	Direct acting with in-built check	3/4"

- Consult Hyspecs for anti-cav performance
- Steel manifold
- \*Non-common stock item – Contact Hyspecs for lead time

## Relief Valves

### 5-Port Cross Line Relief Valves

#### HS1620P12ZBS or P16ZBS\*

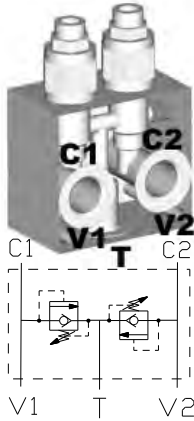

Cartridges	Q max l/min	P max bar	Notes	Ports BSPP
RVCV56-20 x 2	115	420	Direct acting with in-built check	3/4" -1"

- Manifold dimensions 135 x 100 x 50mm (excluding cartridges)
- Consult Hyspecs for anti-cav performance
- Steel manifold
- \*Non-common stock item – *Contact Hyspecs* for lead time

#### HS1220P12W or P16W

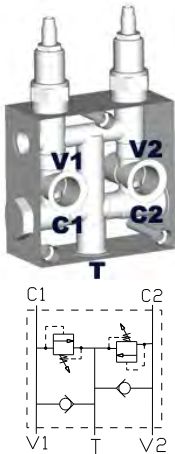

Cartridges	Q max l/min	P max bar	Notes	Ports BSPP
RV12-26 x 2 +CV12-20 x 2	150	207	Pilot-operated	3/4"-1"

- Manifold dimensions, 130 x 115 x 50mm (excluding cartridge)
- Consult Hyspecs for anti-cav performance

#### HS1620P16WS

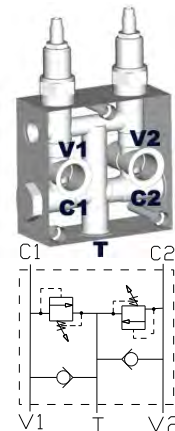

Cartridges	Q max l/min	P max bar	Notes	Ports BSPP
RV56-26 x 2 +CV11-12 x 2	300*	350	Pilot-operated	1"

- Manifold dimensions, 150 x 150 x 70mm (excluding cartridge)
- Steel manifold
- Consult Hyspecs for anti-cav performance
- \* Relieving flow rating only. CV11-12 is rated to 114LPM



## Contents Section L – Electronic Controls

### L1 Electronic Controls

L1	Amplifier Plugs	<i>Eaton</i>
L2	Joysticks	<i>Walvoil</i>
L3	Connectors	<i>Walvoil / Hydraforce</i>
L4	Electronic Control Units	<i>Walvoil / Hydraforce</i>
L6	Radio Remote Controls	<i>Various</i>
L7	Proportional Controls & Joysticks	<i>Various</i>
L7	Mobile and Off Highway Control Systems	<i>Various</i>
L8	Industrial Control Systems	<i>Various</i>
L8	HMI, Operator Controls and Sensors	<i>Various</i>
L9	System Design, Programming, Commission & Support	<i>Various</i>
L9	IOT (internet of things)	<i>Various</i>
L9	Electrical Drives and ePTO's	<i>Danfoss</i>
L10	Synchronous Permanent Magnet Motors	<i>Poclain, e-Comer, Motenergy</i>
L10	Motor Controllers	<i>Various</i>
L10	Terzo EHPU	<i>Terzo</i>
L11	Editron or eLion Drives	<i>Various</i>

## Amplifier Plugs - Eaton

### Eaton Amplifier Plugs

Proportional Power plugs, conforming to ISO 4400/DIN 43650 interface, are designed for compact, electronic control of non-feedback hydraulic proportional and switching valves. This plug/valve combination offers an easy to use, cost-effective alternative to traditional rack mounted machine controls. Din plug mounting, protection to IP67.



Proportional Power Plugs are available in the following configurations:

Type C plugs offer “soft switch” control. Using built in ramps for discrete “on/off” signals, soft switch power plugs with proportional valves help to reduce hydraulic system shocks, improving machine usability and extending life.

Type D and K plugs are controlled with standard analog command signals (0-10V and 4-20mA respectively).

Part	Model Code	Function	Power Supply	Command Signal	Ramp Time	Max O/P Current
02-326009	EHH-AMP-702-C-20	Soft Shift	24VDC	24VDC	50ms - 5s	1.6 Amps
02-326010	EHH-AMP-702-D-20	Prop	24VDC	0-10V	50ms - 5s	1.6 Amps
02-326012	EHH-AMP-702-K-20	Prop	24VDC	4-20mA	50ms - 5s	1.6 Amps
02-326013	EHH-AMP-712-D-20	Prop	12VDC	0-10V	50ms - 5s	3.0 Amps

## Joysticks - Wavoil

### Potentiometric Joysticks

- VJOY joysticks have ratio metric output signal of 25%-75% of Vin.
- Robust construction
- IP66



Code	Part Number	Description
5POT100005	PTM104	Walvoil Potentiometer PTM104 3/4 turn 5K OHM
VJOY200001	MDN142	Walvoil Joystick MDN142 Single Axis Proportional Paddle
VJOY200002	MDN131	Walvoil Joystick MDN131 Single Axis Proportional Mini
VJOY200003	MDN231	Walvoil Joystick MDN231 Dual Axis Proportional Mini

### Fixed Voltage Joysticks

- Hall effect contactless joysticks
- The contactless technology guarantees long life and precise comfortable control
- Robust mechanical design; specifically tailored to off-highway operating machines
- AJW Joysticks available with additional controls on handles
- Fixed output voltage 0.5 – 4.5V



Part Number	Description
183540027	WALVOIL JOYSTICK AJW TWO AXIS PROP. DEADMAN & 1 x PROP. ROLLER
183540028	WALVOIL JOYSTICK AJW TWO AXIS PROP. DEADMAN & 2 x PROP. ROLLER & 1 x ON/OFF
183540029	WALVOIL JOYSTICK AJW TWO AXIS PROP. DEADMAN & 2 x ON/OFF
183540049	WALVOIL JOYSTICK AJW TWO AXIS PROPORTIONAL
3140AE600	APEM JOYSTICK 3000 SERIES SINGLE AXIS 0.5 - 4.5V OUTPUT
3140SE600	APEM JOYSTICK 3000 SERIES DUAL AXIS 0.5 - 4.5V OUTPUT
BH140A01BKBK0500	APEM PADDLE CONTROLLER BH SERIES 0.5 - 4.5V OUTPUT
TW-12BLK13	APEM THUMB WHEEL TW SERIES 0.5 - 4.5V OUTPUT

## Connectors



### Hydraforce Deutsch Connectors

Code	Description
4001976	Hydraforce - Deutsch Connector Kit DTM06-12A Grey
4001977	Hydraforce - Deutsch Connector KIT DTM06-12B Black

### Programming Cables for CED400X Control Unit

Code	Description
DCDSW0170051	Walvoil System Software PHC / V2.0
VCAV600018	Walvoil Programming Cable CED400X

Connector types		
ID	Type	Connection to
D12M	DTM06-12S Deutsch	CED400X control units
D12F	DTM04-12S Deutsch	Harness
C1 + C2	SUB-D 9 poles, female	Personal computer

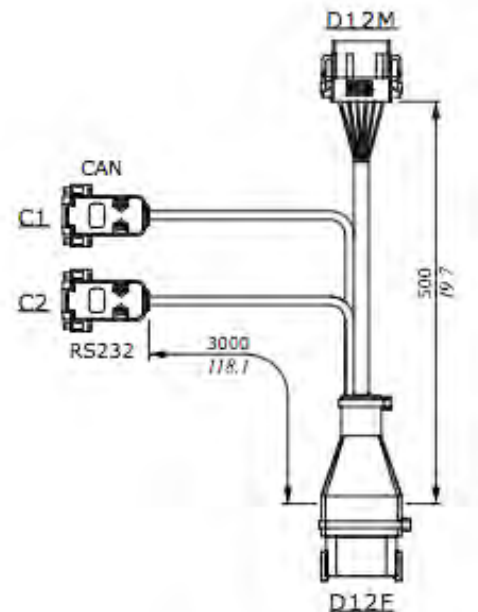

## Electronic Control Units - Walvoil

### CED400X Electronic Control Units

- 12/24 VDC applications
- “Dead man” switch management
- Float function management
- Fast/Slow function management
- Typically used with Walvoil DPC130 or DPC200 valves.

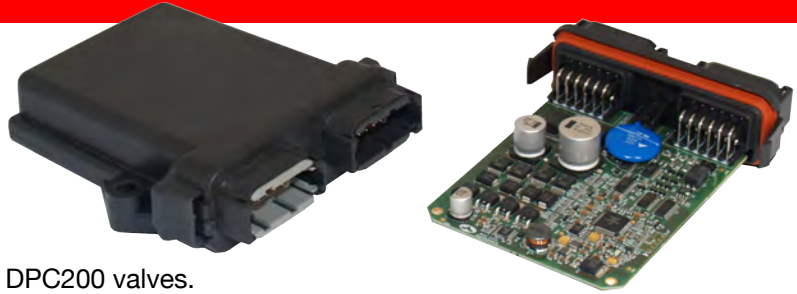

Code	Description
183334003	Walvoil CED400X ECU 4 Proportional Functions 8 x 2A Outputs
183337025*	*new V29.1

General Features	CED400X
Supply voltage	from 8 to 32V
Current consumption	<100 mA
Max. current output	6 A – 12 VDC
Interface	RS232, 9600, 8, n, 1
EMC compatibility	ISO13766, ISO14982
Environmental compatibility	IEC60068-2-6/27/29
Working temperature	From -40 to +85°C
Protection degree	IP67 with mating connector attached
Weight	0.3 Kg
<b>Analog inputs</b>	
Number	up to 4
Signal Type	0/VB or from 0 to 5V
<b>Digital inputs</b>	
Number	up to 6
Signal Type	0/VB, from 0 to 50 KHz
<b>Proportional outputs</b>	
Number	4 pairs
Type	8HSD* + 4LSD*
Signal	PWM on LSD*
Frequency	from 50 to 300 Hz, amplitude from 100 to 300 mA
Max.load	2 A

Notes(\*): HSD - high side drive  
LSD - low side drive

## Electronic Control Units - Hydraforce

### Hydraforce Electronic Control Units (ECU)



HydraForce offer a full line of electronic vehicle control products integrating engine, transmission and other machine functions into a common J1939 or CAN Open Data Link control circuit.

These systems consist of rugged, field-proven components suitable for heavy-duty operating conditions. PWM digital signal logic maximizes efficiency, response and signal integrity under harsh environmental conditions. Reliability has been proven through extensive testing, as well as years of real-world application experience.

This is a complete line of the most rugged, heavy duty vehicle machine controllers, monitors, displays and electrical connectors for motion control and integrated machine control applications in mobile, off-highway and material handling equipment.

- Reliable operation in the most demanding mobile equipment applications
- Operating temperatures from -40 to 85°C
- Chemical splash immunity
- Moisture resistance to IP67 specifications
- Fully resistant to EMI/RFI
- Vibration resistant to 8 Grms (random) 24–200 Hz, 3-axis

***There are many different options available and programming will be required. For more information contact Hyspecs and talk with a sales engineer.***



## Radio Remote Controls

Hyspecs can supply “off the shelf” radio remote controls or work with the customer to develop customised solutions. Minimise operator downtime and fatigue by using our robust handheld & console box transmitters to control your machines. These can be custom built to suit your application.



*There are many different options available and programming will be required. For more information contact Hyspecs and talk with a sales engineer.*



## Proportional Controls & Joysticks

A versatile range of single and dual axis joysticks that can be customized to your requirements.

- Rugged designs up to IP66 with a range of output types.
- Various ergonomic grip types.
- Several grip functions: Domed & flat push button, proportional roller, rocker switch & operator presence switch.



## Mobile and Off Highway Control Systems

Hyspecs can design, build, install, commission and support your mobile or off highway control systems. We offer a vast range of hydraulic or electrical actuators, hydraulic control valves and / or electrical controllers. Controllers can be either hard wired or radio remote.



## Industrial Control Systems

Hyspecs can design, build, install, commission and support your industrial control systems. We offer a vast range of controls and PLCs or build to your requirements.

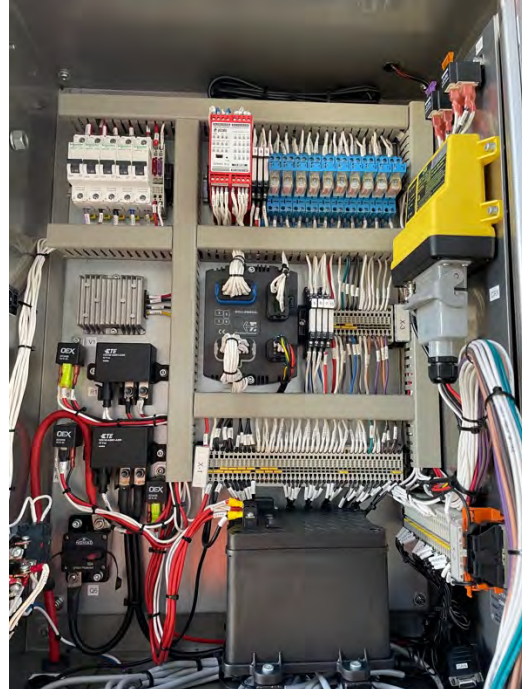

## HMI, Operator Controls & Sensors

Many options are available for programmable displays, operator controls and sensors. Whatever your needs, we can supply a solution to monitor all your hydraulic and electrical functions.



PLUS 



## System Design, Programming, Commissioning & Support

If you require assistance with programming, our team of experts is here to help. We not only offer programming solutions but also provide hardware required for your projects. We are proficient in many programming languages, ensuring that we can cater to your specific needs and offer continuing support.



## IOT

Hyspecs can offer a number of IOT (Internet of Things) solutions. Connectivity can be via cellular services, Wi-Fi networks & Bluetooth connections so there are solutions for nearby & distant remote control. You may want to control machines or appliances from a safe working distance or via the internet to some other location.



## Electrical Drives and e-PTOs

Hyspecs can supply mobile & industrial electrical drives & associated controllers from small to large. Multiple voltage options & control types are available.

Some examples are:

### Danfoss ePanda

- 24 & 48 VDC
- 2500 W to 4000 W (S2-60min)
- IP67
- Air cooled
- Quiet operation
- CAN or analogue control





## Electrical Drives and e-PTOs

### Poclair / e-Comer / Motenergy Synchronous Permanent Magnet motors - Paired with Emsiso or Kelly controllers

Numerous combinations are available to meet most requirements, whether it is e-PTO, hydraulic or direct electric drive.

#### Electric Motors

- Numerous motor sizes
- 24 to 800 Volt
- Different motor mount options

#### Motor controllers

- Rated up to IP6K6
- Conduction cooled capacitors for high continuous power rating
- Motor thermal protection
- CAN communication



### Terzo EHPU

The Hydrapulse® EHPU, electric hydraulic power unit, is a rugged electro-hydraulic pump system with integrated motor, controller and closed-loop pressure feedback that is specifically designed for industrial and mobile applications. The EHPU is available in both high and low voltage models and a variety of pump displacements and power levels.

The Hydrapulse® EHPU can be matched with a gear or piston pump. For low noise level requirements we can offer the Danfoss Shark pump helical gear pump.

- Onboard pressure transducers
- CAN / J1939 communications
- Onboard diagnostics
- Permanent magnet motor
- Power on demand means energy savings
- 200 to 800 VDC
- Integrated cooling (No external cooling required)
- EHPU-1 2.5 kW
- EHPU-2 10 kW



## Electical Drives and e-PTOs

### Editron or eLion

Larger electric machines (up to 1000kW) based on synchronous reluctance assisted permanent magnet (SRPM) or permanent magnet synchronous machine (PMSM) technology. Designed for various off-highway vehicle functions e.g. traction motors in heavy machinery or a propulsion motor in marine applications. They are liquid-cooled and designed to work in harsh operating environments. They can work both as a generator or as a motor.



## Rules-Of-Thumb

- For every 1 kW of drive, the equivalent of 5 lpm @ 100 Bar can be produced
- To idle a pump when it is unloaded will require about 5% of its full rated power.

## Fluid Power Formulas

- For a pump/motor,  
Torque (Nm) = Power (kW) x 9549 / Speed (rpm)
- Force developed by a cylinder,  
Force (N) = Bore Area (cm<sup>2</sup>) x Pressure (Bar) x 10

## Conversions

- 1 U.S. gallon = 231 in<sup>3</sup> = 3.785 L
- 1 L = 0.2642 U.S. gallon = 61.0303 in<sup>3</sup>
- 1 in<sup>3</sup> = 16.387 cc
- 1 Imperial gallon = 1.2 U.S. gallon
- 1 Bar at sea level = 14.504 PSI
- 1 HP = 0.746 kW
- 1 Atmosphere = 1.013 Bar
- 1 km/h = 0.62 mph
- 1 m = 3.28 ft = 39.37 in
- 1 Nm = 0.7376 foot-lbs

## Some Common Fluid Power Symbols

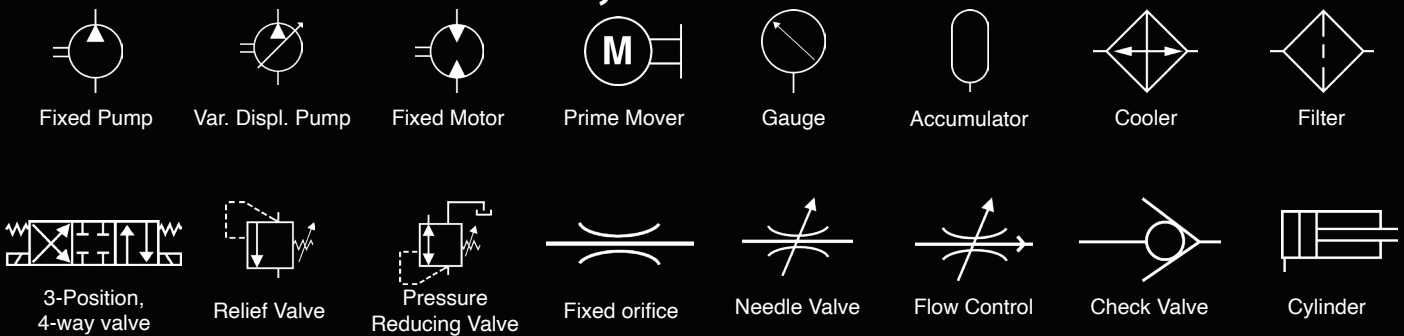

## Key Brands

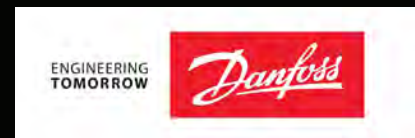

Melbourne



Brisbane



Auckland

© HYDRAULIC SPECIALTIES PTY LTD.

Melbourne | Brisbane | Auckland | Christchurch

1800 497 732

hyspecs@hyspecs.com.au

www.hyspecs.com.au